



SEWON FLAME ARRESTER

Deflagration Flame Arrester ●

SFC
SFG
SFE
SFH
SFO
SFL

Detonation Flame Arrester ●

SFD
SFJ

Flame Check ●

SFK

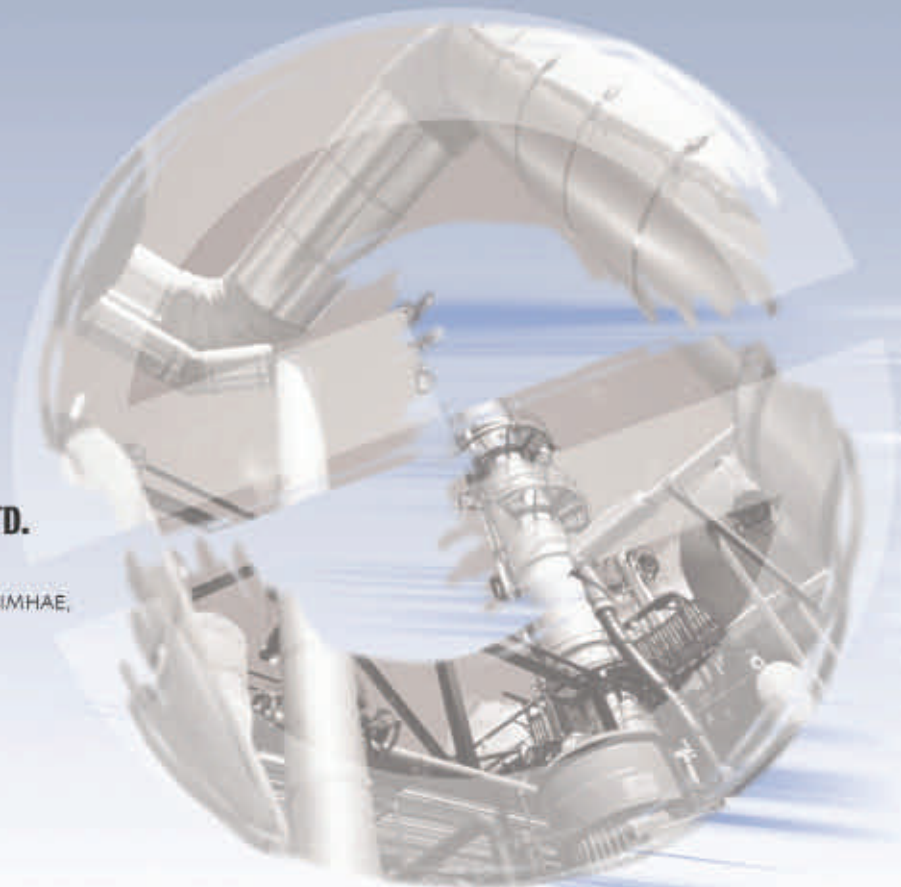

SEWON Q&TECH CO.,LTD.

■ HEAD OFFICE/FACTORY

1038-2, CHUNGOK-RI, JUCHON-MYUN, KIMHAE,
KYEONG-NAM, KOREA. 621-840
Tel: +82-55-323-5894~7
Fax: +82-55-323-5898
<http://www.swqt.co.kr>
<http://www.sewon-ind.co.kr>
E-mail: helpdesk@swqt.co.kr

■ SEOUL OFFICE

3FL, 29-13, KARAK-DONG, SONGPA-KU,
SEOUL, KOREA. 138-160
Tel: +82-2-406-5013~4/406-7021
Fax: +82-2-406-7022
E-mail: helpdesk@swqt.co.kr

FLAME ARRESTER

Sewon Flame Arrester

Flame Arrester

The flame arrester is a device fitted to the opening of an enclosure or to the connection pipework of a system of enclosures and whose intended function is to allow gas flow but prevent the transmission of flame propagation.

Sewon flame arresters can be used to prevent flame propagation in the presence of explosive atmospheres, e.g. through piping, breathers and filling and emptying lines that are not full of liquid at all times. If the formation of a hazardous explosive atmosphere cannot be avoided, e.g. in a non-explosion proof container for flammable liquids, arrangements to arrest flame transmission must be made at permanent openings communicating with places where sources of ignition can be expected to occur and allowing an explosion to be transmitted to the container.



Sewon crimped ribbon arrester stop the propagation of a flame by absorbing and dissipation heat through the surface area of the flame element by lowering the gas temperature below its ignition temperature.

Deflagration & Detonation Flame Arrester

Flame arresting devices are classified as deflagration proof and detonation proof.

Deflagration Flame Arrester

Flame arrester designed to prevent the transmission of a deflagration

A deflagration is the most common mode of flame propagation in accidental gas explosions. It is defined as an explosion where the combustion wave propagates at subsonic velocities relative to the unburned gas immediately ahead of the flame. The explosion pressure will range from a few mbar to several bar, depending on the flame speed. For strong deflagrations, shock waves may propagate ahead of the deflagration.



Detonation Flame Arrester

Flame arrester designed to prevent the transmission of a detonation.

A detonation is the most devastating form of gas explosion.. A detonation is defined as an explosion Propagating at supersonic velocity and characterized by a shock wave. The gas ahead of a detonation is therefore undisturbed by the detonation wave.

Stable detonation

Detonation is stable when it progresses through a confined system without significant variation of velocity and pressure characteristics. In fuel-air mixtures at atmospheric condition, typical velocities range between 1600m/sec and 2200m/sec and the peak pressure is 15-20 bar.

Unstable detonation

Detonation is unstable during the transition of a combustion process from a deflagration into a stable detonation. The transition occurs in a limited spatial zone where the velocity of the combustion wave is not constant and where the explosion pressure is scientifically higher than in a stable detonation.

The position of this transition zone depends on, among other things, the pipe diameter, pipe configuration, test gas and explosion group, and may be established by experiment in each case.

Types of ignition source

European Standard EN 1127-1 distinguishes thirteen types of ignition source:

1. Hot surfaces	8. Radio frequency electromagnetic waves from 10 kHz to 3,000 GHz
2. Flames and hot gases	9. Electromagnetic waves from 300 GHz to 3 x 10 ⁶ GHz
3. Mechanically generated sparks	10. Ionizing radiation
4. Electrical apparatus	11. Ultrasonics
5. Stray electrical currents, cathodic corrosion protection	12. Adiabatic compression and shock waves
6. Static electricity	13. Chemical reactions, including self-ignition of dusts
7. Lightning	

It is very important to take certain precautions in order to avoid any effective ignition sources under normal operating conditions.

Selection of Flame Arrester based on Gas Groups

The flame arrester capability of an explosive gas mixture depends on Maximum Experimental Safe Gap(MESG), and it is segmented into three different gas groups Group IIA, IIB and IIC based on the MESG in European Standard.

Table 1

Explosion Group	CHEMICAL NAME
IIA (MESG > 0.90mm)	2,4-Pentanedione, 2-Diethylaminoethanol, 2-Pentanone, 2-Pexanone, 2-Propanol, 4-Hydroxy-4-Methyl-2-Pentanone, Acetaldehyde, Acetic acid, Acetone, Acetonitrile, Acetylchloride, Allylchloride, Ammonia, Amphetamine, Amylacetate, Aniline, Benzene, Benzotrifluoride, Benzyl chloride, Bromoethane, Butane, Butanol, Butylacetate, Butylamine, Chlorobenzene, Chlorobutane, Chloroethane, Chloromethane, Chloropropane, Coal tar naphtha, Cresol, Cumene, Cyclobutane, Cycloheptane, Cyclohexane, Cyclohexanol, Cyclohexanone, Cyclohexylamine, Cyclopentane, Cyclopropane, Cymene, Decaline, Decane, Dichlorobenzene, Dichloroethane, Dichloroethylene, Dichloromethane, Dichloropropane, Diethylamine, Dimethylamine, Ethane, Ethanediimine, Ethanol, Ethylacetate, Ethylacetoacetate, Ethylbenzene, Ethylcyclobutane, Ethylcyclohexane, Ethylcyclopentane, Ethylene chlorohydrin, Ethylformate, Ethylmercaptane, Ethylmethacrylate, Ethylolamine, Heptane, Heptanol, Hexane, Hexanol, Kerosene, Metaldehyde, Methane, Methanol, Methyl n-amyl ketone, Methylacetate, Methylamine, Methylcyclobutane, Methylcyclohexane, Methylcyclohexanol, Methylcyclopentane, Methylformate, Methylmethacrylate, Motor benzol, N,N-dimethylbenzenamine, Naphthalene, Nitroethane, Nitromethane, Nonane, Nonanol, Octane, Octanol, Pentane, Pentanol, Petroleum naphtha, Phenol, Propane, Propylacetate, Propylamine, Propylene, Propylmercaptane, Pyridine, Styrene, Tetrahydrothiophene, Thiophene, Toluene, Toluidine, Triethylamine, Trimethylamine, Trimethylbenzene, Turpentine, Vinyl chloride, Vinylacetate, Xylene
IIB (MESG > 0.50mm)	1,3 Butadiene, 1,3,5-Trioxane, 1,3-Dioxolane, 1,4-Dioxane, Acrylaldehyde, Acrylonitrile, Butyl glycolate, Carbon monoxide, Crotonaldehyde, Dibutylether, Diethylether, Dimethylether, Dipropylether, Epichlorohydrin, Ethanethiol, Ethylacrylate, Ethylene, Ethyleneoxide, Ethylmethylether, Ethylmethylketone, Furan, Hydrogen cyanide, Isopropenylbenzene, Isopropylnitrate, Methylacrylate, Nitroethane, Propane-1-ol, Propene oxide, Propyne, Tetrafluoroethylene, Tetrahydrofuran, Tetrahydrofurfuryl alcohol
IIC (MESG < 0.50mm)	Acetylene, Carbon disulfide, Hydrogen

Note) The flame arrester must be selected with smallest MESG for mixtrue of several gases.

The Explosion Gas Group is also defined in US NFPA 497 "Recommended Practice for the Classification of Flammable Liquids, Gases, or Vapors and of Hazardous (Classified) Locations for Electrical Installations in Chemical Process Areas"

Table 2

Explosion Group (NFPA 497)	CHEMICAL NAME
Group A	Acetylene
Group B	Flammable gas, flammable liquid produced vapor, or comustible liquid produced vapor mixed with air that may burn orexpode, having either a MESG value less than or equal to 0.45 mm or a minimum igniting current ratio less than or equal to 0.40. A typical gas is hydrogen.
Group C	Flammable gas, flammable liquid produced vapor, or combustible liquid produced vapor mixed with air that may burn or explode, having either a MESG value geater than 0.45 mm and less than or equal to 0.75 mm, or a minimum ighiting current ratio greater than 0.40 and less than or equal to 0.80. A typical gas is ethylene.
Group D	Flammable gas, flammable liquid produced vapor, or combustible liquid produced vapor mixed with air that may burn or explode, having either a MESG value greater than 0.75 mm or a minimum igniting current ratio greater than 0.80. A typical gas is propane.

MODEL SFC FLAME ARRESTER

Sewon SFC Flame Arrester, End-of-Line

NOMINAL SIZE

- 3/4", 1", 1-1/2", 2", 3", 4", 6", 8", 10", and 12"
- Other sizes are available upon request.
- Available EN12874:2001 Certified Model

CONNECTIONS

- ANSI/ASME B16.5 Class 150 Flange
- KS/JIS 10K Flange

Protect storage tank or system from potential ignition source
Easy installation and simple mechanism
Available in size 3/4" to 12"

Self-opening Weather hood Mechanism when burning
Condition occurred
Drilling conforming to ANSI/ASME B16.5 for
class 150 Flanges. or KS/JIS 10K Flanges.
Other standards are available on customer's request.



SIZE 3/4" through 6"

SIZE 8" through 12"

SPECIFICATIONS

Installation	Vertical
Type	End-of-line flame arrester
Classification	Deflagration flame arrester
Normal working pressure	Below 1.0 barg(standard specification)
Explosion gas group	IIA(standard), IIB/IIC(for special application)

MATERIALS

PART NAME	MATERIALS	
	STANDARD	OPTIONAL
BODY	CARBON STEEL, 304 S.S, 316 S.S, ALUMINUM	HASTELLOY [®] , ALLOY 20, MONEL, INCONEL
FLAME ELEMENT	304 S.S, 316 S.S	HASTELLOY [®] , ALLOY 20, MONEL, INCONEL
ELEMENT HOUSING	304 S.S, 316 S.S	HASTELLOY [®] , ALLOY 20, MONEL, INCONEL
WEATHER HOOD	ALUMINUM, 304 S.S, 316 S.S	316L S.S
BOLT AND NUT	C.S, 304 S.S	316 S.S

- Other special materials are available upon customer's request.
Hastelloy[®] is the registered trademark of Haynes international, Inc.

BASIC ORDERING INFORMATION

1. Model and Type
2. Fluid Handling
3. Operating Temperature & Pressure ranges
4. Size and Connection
5. Material

MODEL SFG FLAME ARRESTER

Sewon SFG Flame Arrester, In-line

NOMINAL SIZE

- 1", 1-1/2", 2", 3", 4", 6", 8", 10", and 12"
- 14" through 40" sizes are available upon request.
- Available EN12874:2001 Certified Model

CONNECTIONS

- ANSI/ASME B16.5 Class 150 Flange
- KS/JIS 10K Flange

Protect process line or system from potential ignition source
Easy installation and simple mechanism
Available in size 1" to 40"

Drilling conforming to ANSI/ASME B16.5 for class 150 flanges, or KS/JIS 10K flanges.
Other standards are available on customer's request.

► Consult our factory for special application.



SPECIFICATIONS

Installation	Vertical, recommend Required drain plug for horizontal installation
Type	In-line flame arrester
Classification	Deflagration flame arrester, Bi-directional
Optional equipment	Temperature monitoring sensor
Normal working pressure	Below 1.0 barg (standard specification)
Explosion gas group	IIA (standard), IIB/IIC (for special application)

► Other specifications are available. Consult our factory.

MATERIALS

PART NAME	MATERIALS	
	STANDARD	OPTIONAL
BODY	CARBON STEEL, 304 S.S, 316 S.S, ALUMINUM	HASTELLOY®, ALLOY 20, MONEL, INCONEL
FLAME ELEMENT	304 S.S, 316 S.S	HASTELLOY®, ALLOY 20, MONEL, INCONEL
ELEMENT HOUSING	304 S.S, 316 S.S	HASTELLOY®, ALLOY 20, MONEL, INCONEL
STUD BOLT AND NUT	C.S, 304 S.S	316 S.S

► Other Special materials are available upon customer's request.
Hastelloy® is the registered trademark of Haynes International, Inc.

BASIC ORDERING INFORMATION

1. Model and Type
2. Fluid Handling
3. Operating Temperature & Pressure ranges
4. Size and Connection
5. Material
6. Distance from potential ignition source

MODEL SFE FLAME ARRESTER

Sewon SFE Flame Arrester, In-line

NOMINAL SIZE

- 1-1/2", 2", 3", 4", 6", 8", 10", and 12"
- 14" through 20" sizes are available upon request.

CONNECTIONS

- ANSI/ASME B16.5 Class 150 Flange
- KS/JIS 10K Flange

Protect process line or system from potential ignition source
Available in size 1-1/2" to 20"

Drilling conforming to ANSI/ASME B16.5 For class 150 flanges, or KS/JIS 10K flanges. Other standards are available on customer's request.

► Consult our factory for special application.

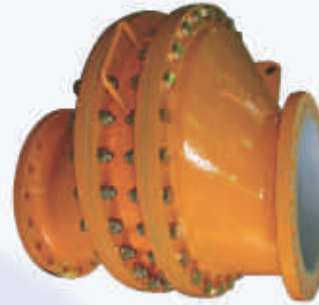

SPECIFICATIONS

Installation	Horizontal
Type	In-line flame arrester
Classification	Deflagration flame arrester, Bi-directional
Normal working pressure	Below 1.0 barg(standard specification)
Explosion gas group	IIA(standard), IIB/IIC(for special application)

► Other specifications are available. consult our factory.

MATERIALS

PART NAME	MATERIALS	
	STANDARD	OPTIONAL
BODY	CARBON STEEL, 304 S.S, 316 S.S, ALUMINUM	HASTELLOY [®] , ALLOY 20, MONEL, INCONEL
FLAME ELEMENT	304 S.S, 316 S.S	HASTELLOY [®] , ALLOY 20, MONEL, INCONEL
ELEMENT HOUSING	304 S.S, 316 S.S	HASTELLOY [®] , ALLOY 20, MONEL, INCONEL
STUD BOLT AND NUT	C.S, 304 S.S	316 S.S

► Other Special materials are available upon customer's request.
Hastelloy[®] is the registered trademark of Haynes International, Inc.

BASIC ORDERING INFORMATION

1. Model and Type
2. Fluid Handling
3. Operating Temperature & Pressure ranges
4. Size and Connection
5. Material
6. Distance from potential ignition source

MODEL SFH FLAME ARRESTER

Sewon SFH Flame Arrester, In-line

NOMINAL SIZE

- 1-1/2", 2", 3", 4", 6", 8", 10", and 12"
- 14" through 20" sizes are available upon request.

CONNECTIONS

- ANSI/ASME B16.5 Class 150 Flange
- KS/JIS 10K Flange

Protect process line or system from potential ignition source
Designed easy periodic inspection and maintenance
Available in size 1-1/2" to 20"

Drilling conforming to ANSI/ASME B16.5 for class 150 flanges, or KS/JIS 10K flanges.
Other standards are available on customer's request.

► Consult our factory for special application.



SPECIFICATIONS

Installation	Vertical, recommend Required drain plug for horizontal installation
Type	In-line flame arrester
Classification	Deflagration flame arrester, Bi-directional
Normal working pressure	Below 1.0 barg (standard specification)
Explosion gas group	IIA (standard)

► Other specifications are available, consult our factory.

MATERIALS

PART NAME	MATERIALS	
	STANDARD	OPTIONAL
BODY	CARBON STEEL, 304 S.S, 316 S.S, ALUMINUM	HASTELLOY [®] , ALLOY 20, MONEL, INCONEL
FLAME ELEMENT	304 S.S, 316 S.S	HASTELLOY [®] , ALLOY 20, MONEL, INCONEL
ELEMENT HOUSING	304 S.S, 316 S.S	HASTELLOY [®] , ALLOY 20, MONEL, INCONEL
BOLT AND NUT	C.S, 304 S.S	316 S.S

► Other Special materials are available upon customer's request.
Hastelloy[®] is the registered trademark of Haynes International, Inc.

BASIC ORDERING INFORMATION

1. Model and Type
2. Fluid Handling
3. Operating Temperature & Pressure ranges
4. Size and Connection
5. Material
6. Distance from potential ignition source

MODEL SFO FLAME ARRESTER

Sewon SFO Flame Arrester, End-of-line

NOMINAL SIZE

- 1-1/2", 2", 2-1/2", 3" and 4"
- Other sizes are available upon request.

CONNECTIONS

- Band with stainless steel hose clamp.

Protect flashback at end-of-line of small pipe
Higher performance compare to wire screen flame arrester
Connect directly with stainless steel hose clamp
Designed easy inspection and maintenance

- ▶ Consult our factory for special application.



SPECIFICATIONS

Installation	End-of-line
Classification	Flame arrester for deflagration; directional
Explosion gas group	IIA

- ▶ Other specifications are available, consult our factory.

MATERIALS

PART NAME	MATERIALS	
	STANDARD	OPTIONAL
BODY	304 S.S	316 S.S
FLAME ELEMENT	304 S.S, 316 S.S	HASTELLOY®, ALLOY 20, MONEL, INCONEL

- ▶ Other special materials are available upon customer's request.
Hastelloy® is the registered trademark of Haynes international, Inc.

BASIC ORDERING INFORMATION

1. Model and Type
2. Fluid Handling
3. Operating Temperature & Pressure ranges
4. Size and Connection
5. Material

MODEL SFL FLAME ARRESTER

Sewon SFL Flame Arrester, In-line

NOMINAL SIZE

- 3/4", 1", 1-1/2", 2", 3", 4", 6", 8", 10" and 12"
- Other sizes are available upon request.

CONNECTIONS

- ANSI/ASME B16.5 Class 150 Flange
- KS/JIS 10K Flange

Sewon SFL perforated plate flame arrester is used primarily for deflagration arresters. The perforated plate is stainless steel as standard material. The flame arresters are available with a wide range of hole diameters and plate thicknesses.

Protect storage tank or system from potential ignition source
Easy installation and simple structure
Available in size 3/4" to 12"

Drilling conforming to ANSI/ASME B16.5 for class 150 flanges, or KS/JIS 10K flanges. Other standards are available on customer's request.



SPECIFICATIONS

Installation	Vertical / Horizontal
Type	In-line flame arrester, Perforated plate flame arrester
Classification	Deflagration flame arrester

MATERIALS

PART NAME	MATERIALS	
	STANDARD	OPTIONAL
BODY	304 S.S	304 S.S, 316 S.S
BOLT AND NUT(Optional)	A193-B7 / A194-2H	304 S.S, 316 S.S
GASKET(Optional)	PTFE Teflon	Non-Asbestos, EPDM

► Other special materials and special designs are available upon request.

MODEL SFD FLAME ARRESTER

Sewon SFD Flame Arrester, In-line

NOMINAL SIZE

- 2", 3", 4", 6", 8", 10", and 12"
- 14" through 24" sizes are available upon request.

CONNECTIONS

- ANSI/ASME B16.5 Class 150 Flange
- KS/JIS 10K Flange

Protect process line or system from potential ignition source
Available in size 2" to 24"

Drilling conforming to ANSI/ASME B16.5 for class 150 flanges, or KS/JIS 10K flanges.
Other standards are available on customer's request.

► Consult our factory for special application.



SPECIFICATIONS

Installation	Vertical, recommend Required drain plug for horizontal installation
Type	In-line flame arrester
Classification	Detonation flame arrester, Bi-directional
Special design to detonation	Included shock absorber, and certified by KIMM (KIMM: Korea Institute of Machinery & Materials)

► Other specifications are available. consult our factory.

MATERIALS

PART NAME	MATERIALS	
	STANDARD	OPTIONAL
BODY	CARBON STEEL, 304 S.S, 316 S.S	HASTELLOY [®] , ALLOY 20, MONEL, INCONEL
FLAME ELEMENT	304 S.S, 316 S.S	HASTELLOY [®] , ALLOY 20, MONEL, INCONEL
ELEMENT HOUSING	304 S.S, 316 S.S	HASTELLOY [®] , ALLOY 20, MONEL, INCONEL
STUD BOLT AND NUT	C.S, 304 S.S	316 S.S

► Other Special materials are available upon customer's request.
Hastelloy[®] is the registered trademark of Haynes International, Inc.

BASIC ORDERING INFORMATION

1. Model and Type
2. Fluid Handling
3. Operating Temperature & Pressure ranges
4. Size and Connection
5. Material

MODEL SFJ FLAME ARRESTER

Sewon SFJ Flame Arrester, In-line

NOMINAL SIZE

- 2", 3", 4", 6", 8", 10", and 12"
- Other sizes are available upon request.

CONNECTIONS

- ANSI/ASME B16.5 Class 150 Flange
- KS/JIS 10K Flange

Protect process line or system from potential ignition source

Connection: 90 degrees bend

Available in size 2" to 12"

Drilling conforming to ANSI/ASME B16.5 for class 150 flanges, or KS/JIS 10K flanges. Other standards are available on customer's request.

► Consult our factory for special application.



SPECIFICATIONS

Installation	Vertical
Type	In-line flame arrester
Classification	Detonation flame arrester, directional
Normal working pressure	Below 1.0 barg(standard specification)
Explosion gas group	IIA(standard), IIB/IIC(for special application)

► Other specifications are available, consult our factory.

MATERIALS

PART NAME	MATERIALS	
	STANDARD	OPTIONAL
BODY	CARBON STEEL, 304 S.S, 316 S.S	HASTELLOY®, ALLOY 20, MONEL, INCONEL
FLAME ELEMENT	304 S.S, 316 S.S	HASTELLOY®, ALLOY 20, MONEL, INCONEL
ELEMENT HOUSING	304 S.S, 316 S.S	HASTELLOY®, ALLOY 20, MONEL, INCONEL
BOLT AND NUT	C.S, 304 S.S	316 S.S

► Other Special materials are available upon customer's request.
Hastelloy® is the registered trademark of Haynes International, Inc.

BASIC ORDERING INFORMATION

1. Model and Type
2. Fluid Handling
3. Operating Temperature & Pressure ranges
4. Size and Connection
5. Material

MODEL SFK FLAME ARRESTER

Sewon SFK Flame Check

NOMINAL SIZE

- 1/2", 3/4" and 1"
- Other sizes are available upon request

CONNECTIONS

- NPT Female / Male
- ANSI/ASME B16.5 Class 150 Flange
- KS/JIS 10K Flange

Protect flashback in small process lines containing flammable gases.
Available in size 1/2" to 1"

Designed easy inspection and maintenance
Drilling conforming to NTP(ANSI/ASME B1.20.1)
ANSI/ASME B16.5 for class 150 flanges, or KS/JIS 10K flanges.
Other standards are available on customer's request.

► Consult our factory for special application.



SPECIFICATIONS

Installation	In-line
Classification	Flame check for deflagration, Bi-directional
Explosion gas group	IIA

► Other specifications are available, consult our factory.

MATERIALS

PART NAME	MATERIALS	
	STANDARD	OPTIONAL
BODY	304 S.S	316 S.S, CARBON STEEL
FLAME ELEMENT	304 S.S, 316 S.S	HASTELLOY [®] , ALLOY 20, MONEL, INCONEL

► Other Special materials are available upon customer's request.
Hastelloy[®] is the registered trademark of Haynes International, Inc.

BASIC ORDERING INFORMATION

1. Model and Type
2. Fluid Handling
3. Operating Temperature & Pressure ranges
4. Size and Connection
5. Material
6. Distance from potential ignition source

FLOW CAPACITY

Sewon SFC, End-of-Line Deflagration Flame Arrester

Pressure Drop		Air Flow Rates in 1,000 Nm ³ /h							
mmH ₂ O	mbar	1"	2"	3"	4"	6"	8"	10"	12"
25	2.5	0.052	0.108	0.190	0.308	0.490	1.033	1.629	2.320
50	4.9	0.082	0.164	0.300	0.478	0.780	1.613	2.536	3.693
75	7.4	0.107	0.211	0.395	0.630	1.026	2.144	3.365	4.903
100	9.8	0.128	0.252	0.479	0.767	1.243	2.632	4.126	5.986
150	15	0.165	0.321	0.625	1.006	1.621	3.497	5.472	7.876
200	20	0.196	0.378	0.750	1.211	1.950	4.239	6.627	9.501
250	25	0.225	0.429	0.862	1.393	2.245	4.884	7.630	10.935
300	30	0.252	0.475	0.963	1.556	2.512	5.451	8.513	12.220
350	34	0.277	0.518	1.055	1.703	2.756	5.955	9.299	13.380
400	39	0.301	0.558	1.140	1.839	2.978	6.407	10.006	14.433
450	44	0.323	0.595	1.217	1.963	3.181	6.817	10.649	15.390
500	49	0.345	0.631	1.288	2.078	3.366	7.191	11.239	16.263
600	59	0.383	0.697	1.412	2.282	3.689	7.854	12.291	17.783
700	69	0.418	0.757	1.517	2.456	3.959	8.429	13.211	19.047
800	79	0.449	0.811	1.606	2.606	4.183	8.935	14.030	20.100

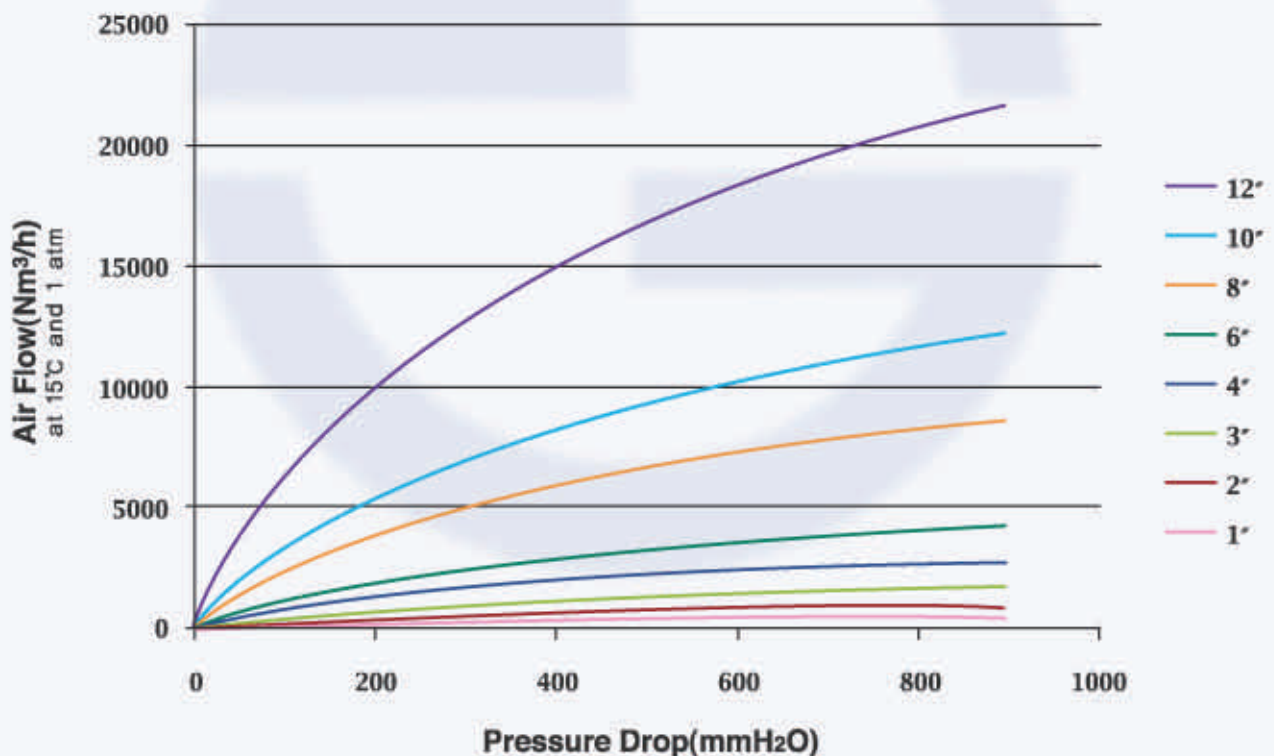

Notes

- Flow rates are not included exit losses and entrance losses.
The flow rates are based on the Sewon Standard Model.
For special application to achieve better flow rate performance, please consult to factory.
- If the inlet pressure is not listed above Table, use liner interpolation.

SEWON SFG, In-Line Deflagration Flame Arrester

Pressure Drop		Air Flow Rates In 1,000 Nm ³ /h							
mmH ₂ O	mbar	1"	2"	3"	4"	6"	8"	10"	12"
25	2.5	0.056	0.127	0.224	0.368	0.699	1.215	1.916	2.729
50	4.9	0.089	0.193	0.353	0.572	1.113	1.897	2.984	4.345
75	7.4	0.117	0.249	0.465	0.754	1.463	2.522	3.959	5.768
100	9.8	0.140	0.297	0.564	0.917	1.773	3.096	4.854	7.042
150	15	0.179	0.378	0.735	1.203	2.311	4.114	6.438	9.266
200	20	0.214	0.446	0.883	1.449	2.780	4.987	7.797	11.177
250	25	0.245	0.505	1.014	1.666	3.201	5.746	8.977	12.865
300	30	0.274	0.560	1.133	1.860	3.582	6.413	10.015	14.376
350	34	0.302	0.610	1.242	2.037	3.930	7.006	10.940	15.741
400	39	0.328	0.657	1.341	2.199	4.246	7.538	11.772	16.980
450	44	0.352	0.702	1.432	2.348	4.535	8.020	12.528	18.106
500	49	0.375	0.744	1.515	2.485	4.799	8.460	13.222	19.133
600	59	0.417	0.822	1.662	2.729	5.260	9.240	14.460	20.921
700	69	0.455	0.892	1.785	2.937	5.645	9.916	15.542	22.409
800	79	0.488	0.956	1.889	3.116	5.965	10.512	16.505	23.647

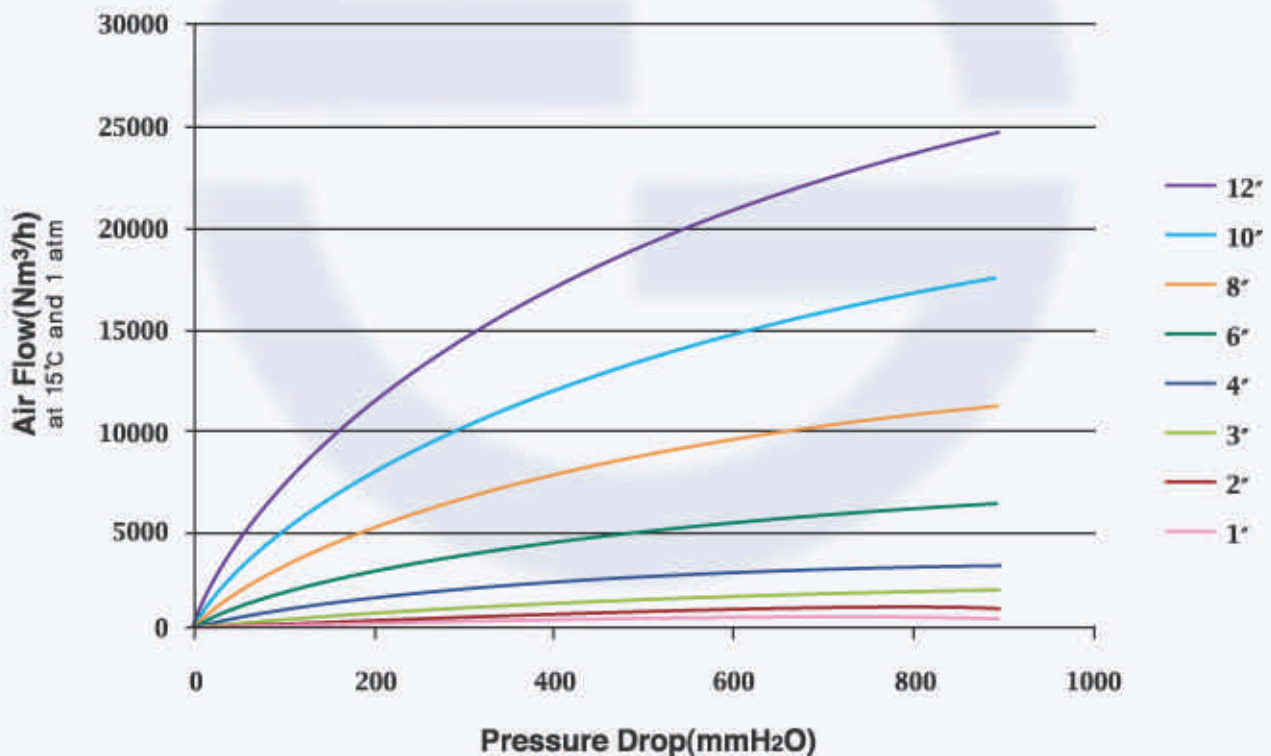

Notes

- Flow rates are not included exit losses and entrance losses.
The flow rates are based on the Sewon Standard Model.
For special application to achieve better flow rate performance, please consult to factory.
- If the inlet pressure is not listed above Table, use liner interpolation.

FLOW CAPACITY

Sewon SFH, In-Line Deflagration Flame Arrester

Pressure Drop		Air Flow Rates in 1,000 Nm ³ /h							
mmH ₂ O	mbar	1-1/2"	2"	3"	4"	6"	8"	10"	12"
25	2.5	0.078	0.098	0.209	0.362	0.692	1.119	1.597	2.886
50	4.9	0.119	0.148	0.330	0.563	1.102	1.747	2.486	4.596
75	7.4	0.153	0.191	0.435	0.741	1.449	2.323	3.300	6.101
100	9.8	0.183	0.228	0.527	0.902	1.755	2.852	4.045	7.449
150	15	0.233	0.291	0.687	1.184	2.288	3.789	5.365	9.800
200	20	0.274	0.343	0.825	1.425	2.753	4.593	6.497	11.822
250	25	0.311	0.389	0.948	1.639	3.169	5.292	7.481	13.607
300	30	0.344	0.431	1.059	1.830	3.547	5.907	8.346	15.205
350	34	0.375	0.469	1.160	2.004	3.891	6.453	9.116	16.649
400	39	0.404	0.505	1.253	2.163	4.204	6.943	9.810	17.959
450	44	0.432	0.540	1.337	2.310	4.490	7.387	10.440	19.151
500	49	0.458	0.572	1.415	2.444	4.752	7.792	11.019	20.236
600	59	0.506	0.632	1.552	2.684	5.208	8.511	12.050	22.128
700	69	0.549	0.686	1.668	2.890	5.589	9.134	12.952	23.701
800	79	0.588	0.735	1.765	3.066	5.906	9.682	13.755	25.011

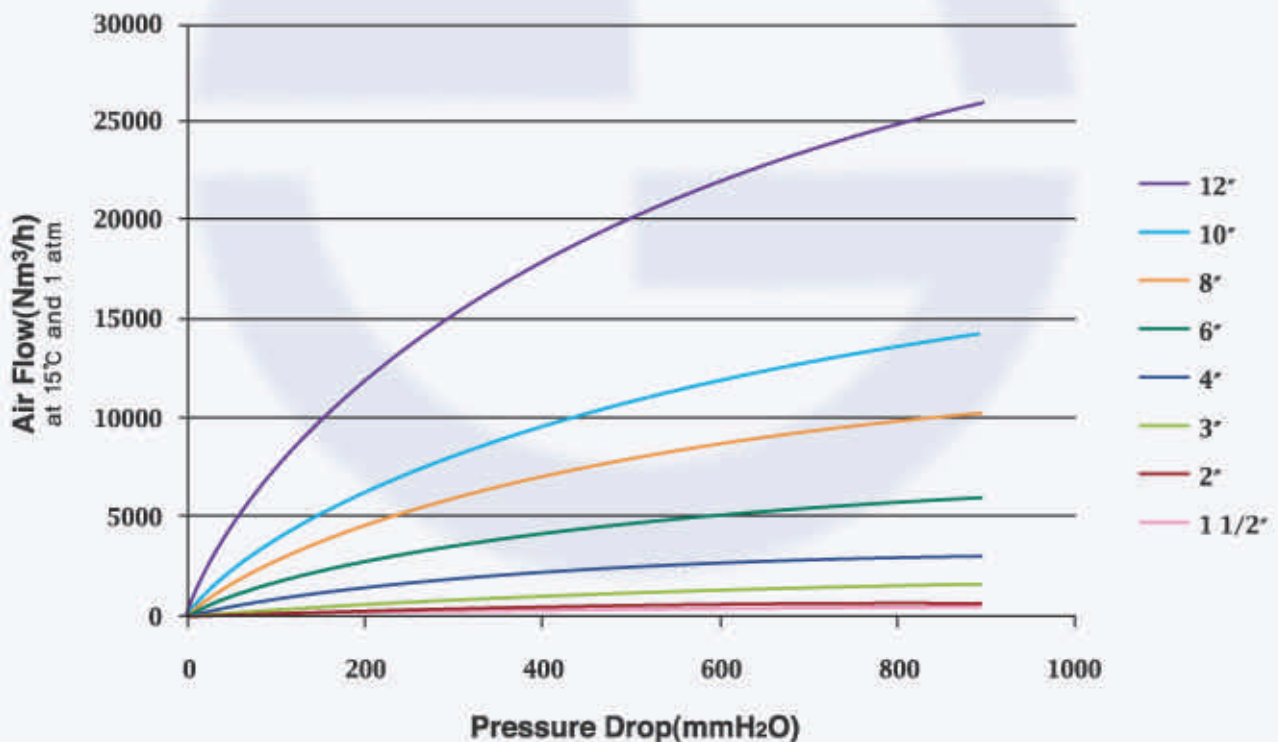

Notes

- Flow rates are not included exit losses and entrance losses.
The flow rates are based on the Sewon Standard Model.
For special application to achieve better flow rate performance, please consult to factory.
- If the inlet pressure is not listed above Table, use liner interpolation.

SEWON SFE, In-Line Deflagration Flame Arrester

Pressure Drop		Air Flow Rates In 1,000 Nm ³ /h							
mmH ₂ O	mbar	1-1/2"	2"	3"	4"	6"	8"	10"	12"
25	2.5	0.078	0.122	0.224	0.371	0.681	1.183	1.857	2.650
50	4.9	0.119	0.185	0.353	0.577	1.083	1.847	2.890	4.220
75	7.4	0.153	0.239	0.464	0.760	1.425	2.456	3.836	5.601
100	9.8	0.183	0.285	0.563	0.925	1.726	3.015	4.703	6.839
150	15	0.233	0.363	0.734	1.213	2.250	4.005	6.237	8.998
200	20	0.274	0.429	0.882	1.461	2.707	4.856	7.553	10.855
250	25	0.311	0.486	1.013	1.680	3.117	5.595	8.696	12.494
300	30	0.344	0.538	1.132	1.876	3.488	6.244	9.702	13.961
350	34	0.375	0.586	1.240	2.054	3.826	6.821	10.598	15.287
400	39	0.404	0.632	1.339	2.217	4.134	7.339	11.404	16.490
450	44	0.432	0.675	1.430	2.367	4.416	7.809	12.137	17.584
500	49	0.458	0.715	1.513	2.506	4.673	8.237	12.809	18.581
600	59	0.506	0.790	1.659	2.751	5.121	8.997	14.008	20.317
700	69	0.549	0.858	1.783	2.962	5.496	9.656	15.057	21.762
800	79	0.588	0.919	1.887	3.142	5.808	10.235	15.990	22.965

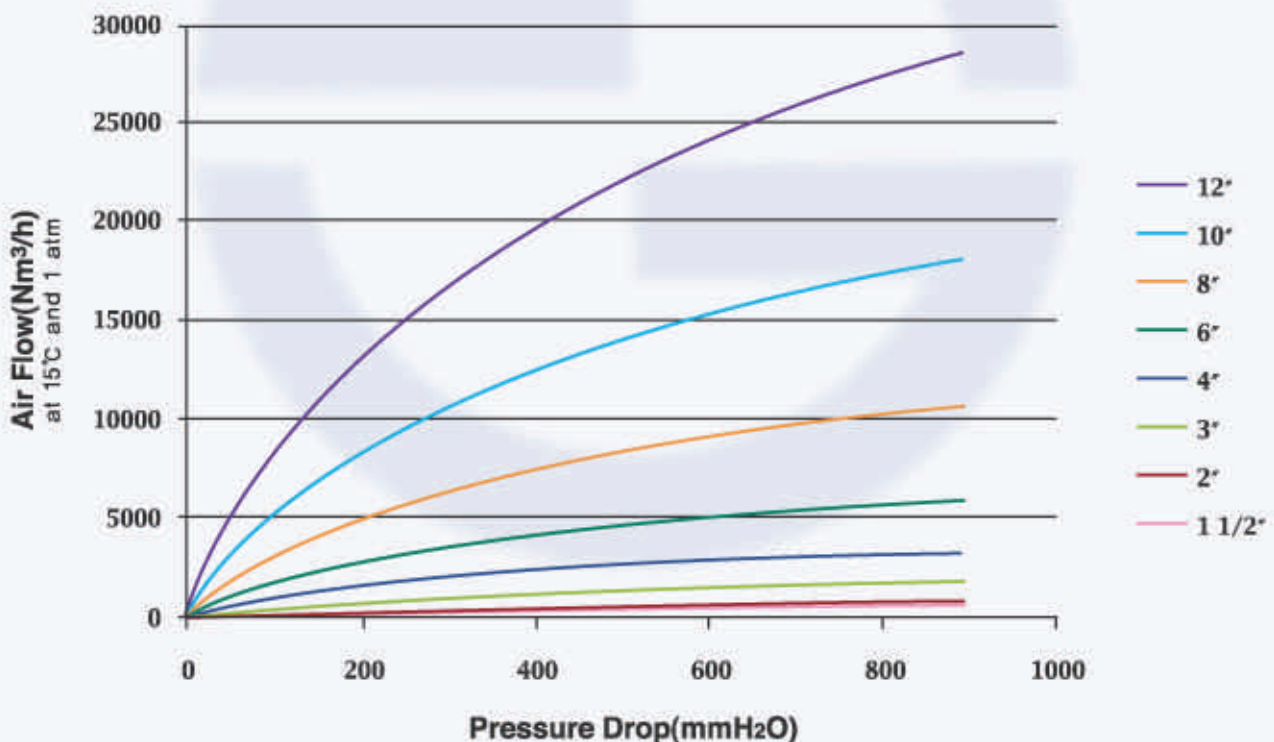

Notes

- Flow rates are not included exit losses and entrance losses.
The flow rates are based on the Sewon Standard Model.
For special application to achieve better flow rate performance, please consult to factory.
- If the inlet pressure is not listed above Table, use liner interpolation.

FLOW CAPACITY

Sewon SFO, End-of-Line Deflagration Flame Arrester

Pressure Drop		Air Flow Rates in 1,000 Nm ³ /h				
mmH ₂ O	mbar	1-1/2"	2"	2-1/2"	3"	4"
25	2.5	0.062	0.347	0.357	0.402	0.555
50	4.9	0.086	0.492	0.526	0.592	0.817
75	7.4	0.100	0.579	0.641	0.722	1.025
100	9.8	0.112	0.649	0.729	0.822	1.198
150	15	0.133	0.775	0.872	0.984	1.481
200	20	0.154	0.893	0.998	1.126	1.720
250	25	0.173	1.006	1.116	1.259	1.935
300	30	0.192	1.114	1.227	1.385	2.136
350	34	0.209	1.217	1.334	1.505	2.325
400	39	0.226	1.315	1.436	1.620	2.504
450	44	0.243	1.409	1.533	1.729	2.674
500	49	0.258	1.498	1.626	1.834	2.837
600	59	0.287	1.665	1.800	2.030	3.139
700	69	0.313	1.817	1.958	2.208	3.414
800	79	0.337	1.956	2.103	2.371	3.664

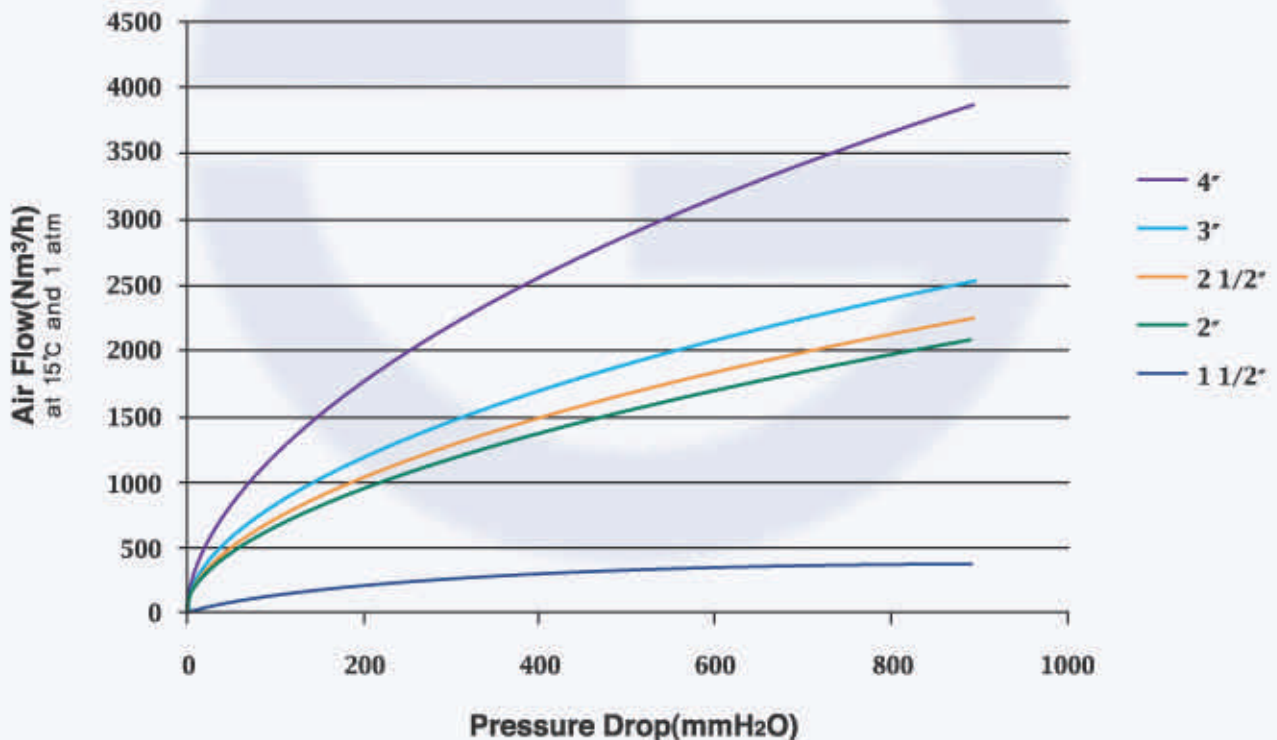

Notes

- Flow rates are not included exit losses and entrance losses.
The flow rates are based on the Sewon Standard Model.
For special application to achieve better flow rate performance, please consult to factory.
- If the inlet pressure is not listed above Table, use liner interpolation.

SEWON SFD, IN-Line Detonation Flame Arrester

Pressure Drop		Air Flow Rates In 1,000 Nm ³ /h						
mmH ₂ O	mbar	2"	3"	4"	6"	8"	10"	12"
25	2.5	0.084	0.155	0.299	0.530	0.791	1.125	1.829
50	4.9	0.116	0.237	0.431	0.832	1.232	1.782	2.839
75	7.4	0.135	0.303	0.515	1.094	1.605	2.368	3.620
100	9.8	0.152	0.359	0.587	1.326	1.932	2.898	4.278
150	15	0.183	0.454	0.720	1.725	2.496	3.829	5.414
200	20	0.213	0.538	0.848	2.065	2.990	4.636	6.441
250	25	0.242	0.616	0.970	2.369	3.441	5.358	7.413
300	30	0.269	0.691	1.088	2.648	3.866	6.019	8.343
350	34	0.296	0.763	1.202	2.908	4.269	6.634	9.238
400	39	0.321	0.833	1.311	3.154	4.655	7.212	10.100
450	44	0.345	0.901	1.417	3.387	5.026	7.759	10.930
500	49	0.368	0.966	1.518	3.610	5.382	8.280	11.730
600	59	0.411	1.091	1.710	4.026	6.054	9.253	13.243
700	69	0.451	1.208	1.887	4.408	6.676	10.146	14.647
800	79	0.488	1.318	2.052	4.759	7.252	10.967	15.951

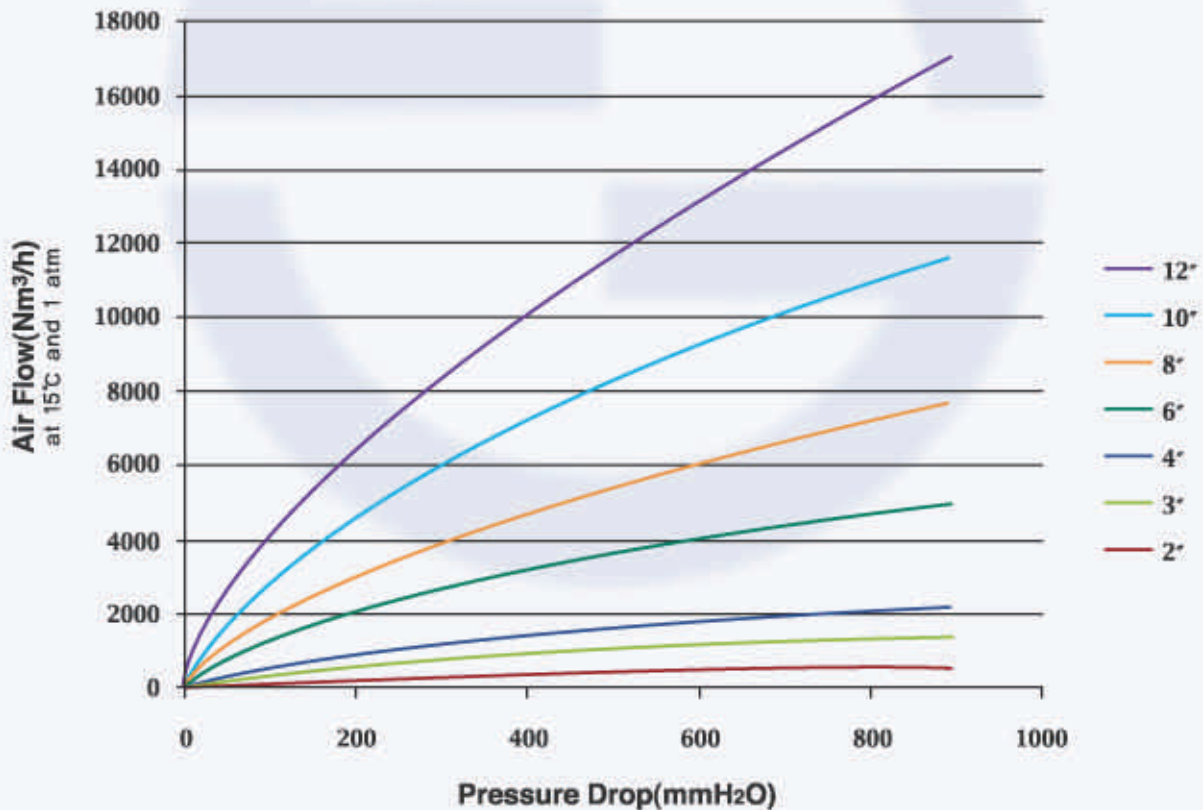

Notes

- Flow rates are not included exit losses and entrance losses.
The flow rates are based on the Sewon Standard Model.
For special application to achieve better flow rate performance, please consult to factory.
- If the inlet pressure is not listed above Table, use liner interpolation.

FLOW CAPACITY

SEWON SFJ, IN-Line Detonation Flame Arrester

Pressure Drop		Air Flow Rates in 1,000 Nm ³ /h					
mmH ₂ O	mbar	2"	3"	4"	6"	8"	10"
25	2.5	0.041	0.103	0.143	0.281	0.510	0.861
50	4.9	0.062	0.154	0.219	0.428	0.767	1.279
75	7.4	0.080	0.189	0.280	0.559	0.994	1.651
100	9.8	0.096	0.215	0.330	0.676	1.196	1.986
150	15	0.123	0.258	0.411	0.878	1.541	2.564
200	20	0.145	0.296	0.478	1.046	1.830	3.051
250	25	0.164	0.332	0.537	1.191	2.080	3.471
300	30	0.182	0.367	0.592	1.320	2.302	3.843
350	34	0.198	0.401	0.645	1.437	2.504	4.179
400	39	0.213	0.435	0.696	1.544	2.690	4.487
450	44	0.227	0.468	0.745	1.646	2.866	4.772
500	49	0.240	0.500	0.792	1.742	3.031	5.040
600	59	0.265	0.562	0.883	1.925	3.340	5.534
700	69	0.287	0.622	0.969	2.098	3.624	5.982
800	79	0.307	0.680	1.050	2.264	3.887	6.394

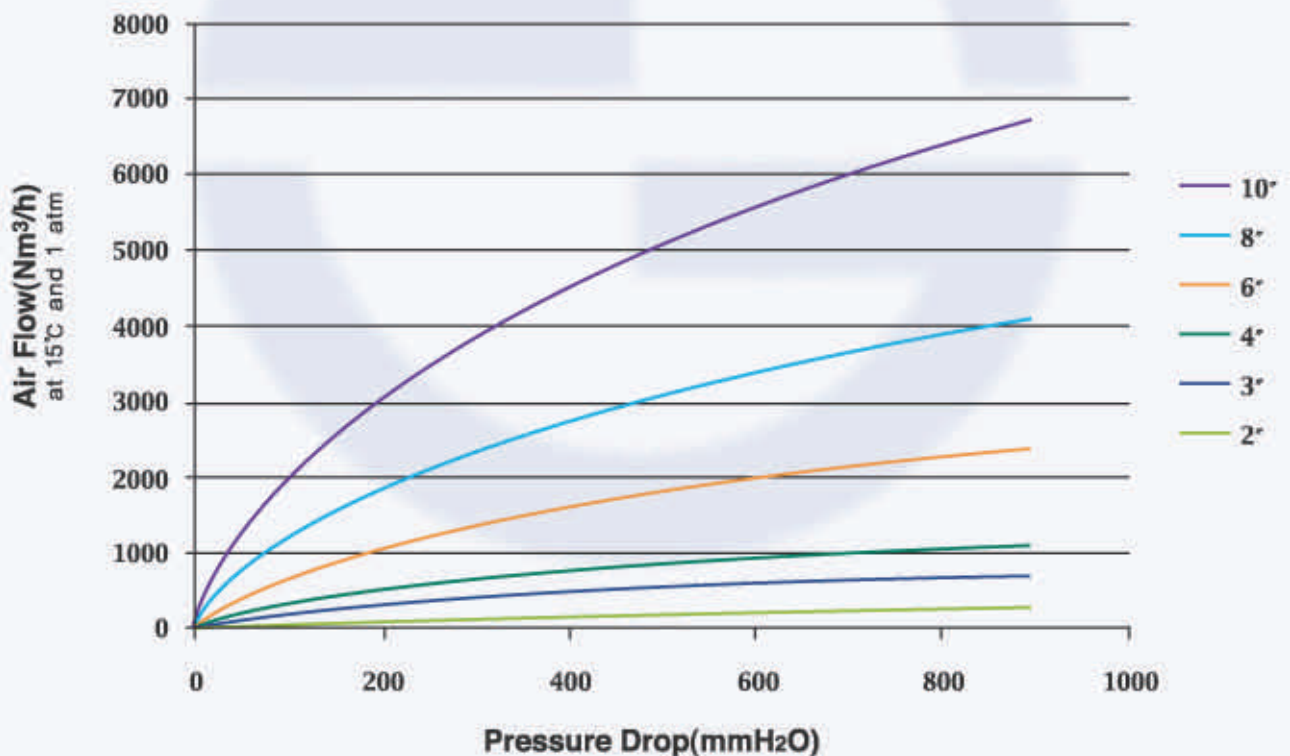

Notes

- Flow rates are not included exit losses and entrance losses.
The flow rates are based on the Sewon Standard Model.
For special application to achieve better flow rate performance, please consult to factory.
- If the inlet pressure is not listed above Table, use liner interpolation.

SEWON SFK, Flame Check

Pressure Drop		Air Flow Rates In 1,000 Nm ³ /h		
mmH ₂ O	mbar	1/2"	3/4"	1"
25	2.5	0.004	0.005	0.006
50	4.9	0.006	0.008	0.009
75	7.4	0.007	0.010	0.011
100	9.8	0.008	0.011	0.013
150	15	0.010	0.014	0.016
200	20	0.012	0.015	0.019
250	25	0.013	0.017	0.021
300	30	0.014	0.019	0.023
350	34	0.015	0.020	0.025
400	39	0.016	0.022	0.027
450	44	0.017	0.023	0.029
500	49	0.018	0.024	0.030
600	59	0.020	0.026	0.033
700	69	0.021	0.028	0.035
800	79	0.023	0.030	0.037

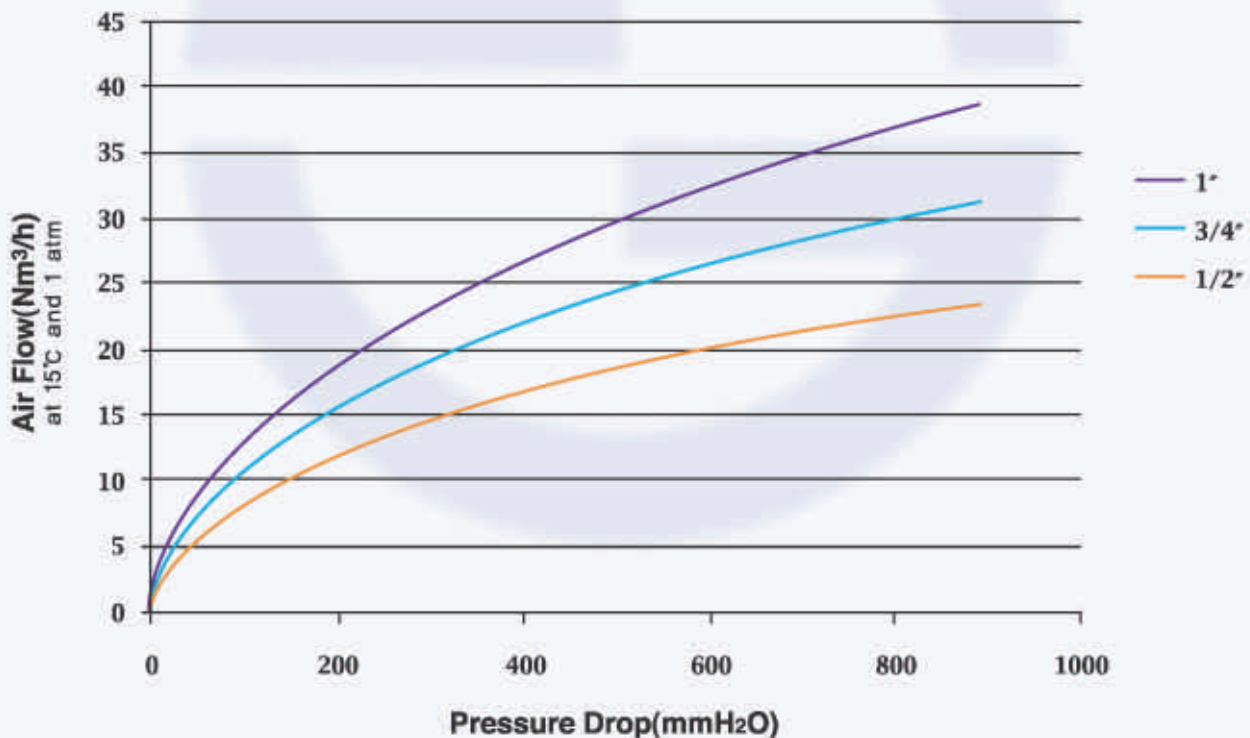

Notes

- Flow rates are not included exit losses and entrance losses.
The flow rates are based on the Sewon Standard Model.
For special application to achieve better flow rate performance, please consult to factory.
- If the inlet pressure is not listed above Table, use liner interpolation.

DIMENSIONS

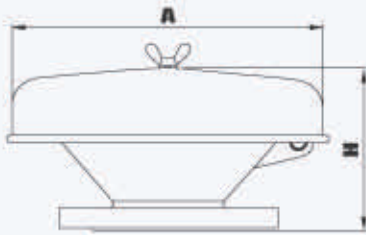

MODEL SFC, 3/4 " to 6 "

Size (inch)	H (mm)	A (mm)	Approx. Weight [Kg]	
			C.S	Aluminum
3/4 "	150	160	6	5
1 "	150	160	6	5
1-1/2 "	160	220	8	7
2 "	160	220	10	7
3 "	165	270	14	9
4 "	175	320	20	11
6 "	215	425	24	14

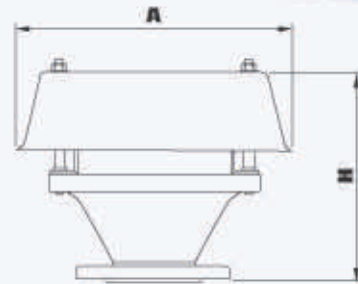

MODEL SFC, 8 " to 20 "

Size (inch)	H (mm)	A (mm)	Approx. Weight [Kg]	
			C.S	Aluminum
8 "	255	520	38	20
10 "	265	620	52	34
12 "	285	700	74	48
14 "	325	850	150	60
16 "	345	920	170	68
18 "	365	1020	200	80
20 "	385	1100	237	95

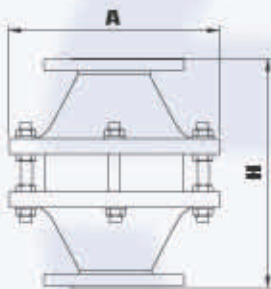

MODEL SFG

Size (inch)	H (mm)	A (mm)	Approx. Weight [Kg]	
			C.S	Aluminum
1 "	215	170	7	4
1-1/2 "	255	180	10	6
2 "	285	225	14	8
2-1/2 "	295	240	18	9.5
3 "	305	260	23	11
4 "	305	320	36	18
6 "	370	410	73	36
8 "	385	485	105	61
10 "	395	595	155	107
12 "	405	635	205	156
14 "	475	800	350	184
16 "	495	860	360	204
18 "	520	930	390	230
20 "	540	1000	435	260

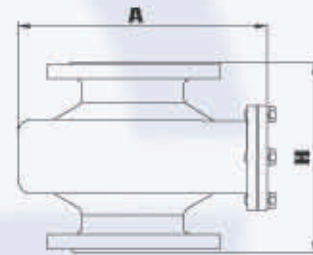

MODEL SFH

Size (inch)	H (mm)	A (mm)	Approx. Weight [Kg]	
			C.S	Aluminum
1 "	-	-	-	-
1-1/2 "	160	175	10	9
2 "	200	180	15	9
2-1/2 "	200	220	24	12
3 "	210	240	31	14.5
4 "	230	305	36	16
6 "	280	420	71	28
8 "	370	470	87	34
10 "	380	500	112	45
12 "	380	580	178	71

Actual dimensions may vary from these listed dimensions due to variations or revisions of specifications. The dimensions may change without notice. For more information, consult our factory.

DIMENSIONS

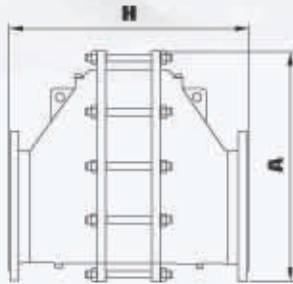

MODEL SFE

Size (inch)	H (mm)	A (mm)	Approx. Weight [Kg]	
			C.S	Aluminum
1-1/2"	255	175	-	-
2"	285	225	16	8
3"	305	255	24	11
4"	355	320	45	18
6"	370	410	80	32
8"	385	485	152	61
10"	515	600	267	107
12"	515	650	390	156

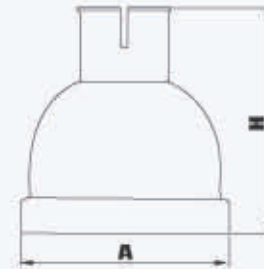

MODEL SFO

Size (inch)	H (mm)	A (mm)	Approx. Weight [Kg]
			Stainless Steel
1-1/2"	115	104.4	0.6
2"	140	142.9	1
2-1/2"	150	167.9	1.3
3"	150	167.9	1.3
4"	180	219.2	2

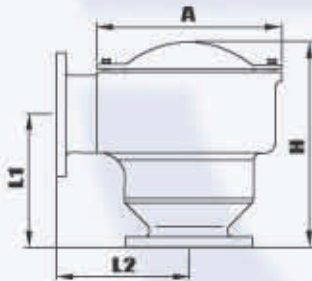

MODEL SFJ

Size (inch)	H (mm)	L1 (mm)	L2 (mm)	A (mm)	Approx. Weight [Kg]
					C.S
2"	250	170	150	180	42
3"	310	210	175	220	63
4"	365	250	240	290	94
6"	495	300	300	415	120
8"	575	350	350	585	200
10"	650	450	450	680	280
12"	Consult factory				

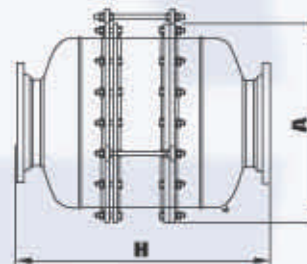

MODEL SFD

Size (inch)	H (mm)	A (mm)	Approx. Weight [Kg]
			C.S
2"	500	280	-
3"	500	280	70
4"	600	330	80
6"	750	445	150
8"	800	560	200
10"	900	675	320
12"	1100	795	450
14"	1300	905	570
16"	1500	1020	750
18"	1700	1120	890
20"	1900	1235	1100
24"	2300	1465	1420

Actual dimensions may vary from these listed dimensions due to variations or revisions of specifications. The dimensions may change without notice. For more information, consult our factory.

DIMENSIONS

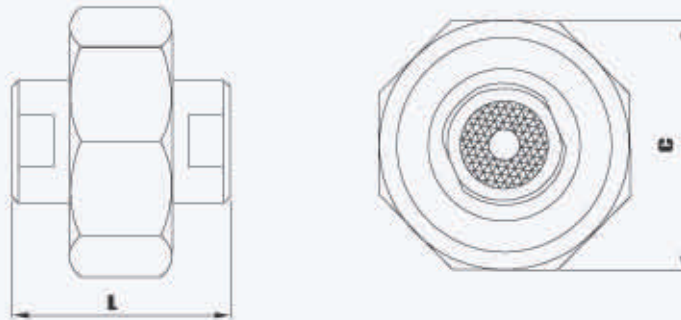

MODEL SFK

Size (inch)	L (mm)	C (mm)	Approx. Weight [Kg]
			Stainless Steel
1/2"	60	64	1
3/4"	70	78	1.4
1"	70	78	2

Actual dimensions may vary from these listed dimensions due to variations or revisions of specifications. The dimensions may change without notice. For more information, consult our factory.

HOW TO ORDER

MODEL	SIZE	MATERIALS	FLANGE DRILLING	OPTION
<div style="text-align: center;">□□□</div> <div style="text-align: center;">↓</div> SFC SFG SFE SFH SFO SFD SFJ SFK SFL	<div style="text-align: center;">□□</div> <div style="text-align: center;">↓</div> A1 : 1/2" A2 : 3/4" 01 : 1" 1A : 1-1/2" 02 : 2" 2A : 2-1/2" 03 : 3" 04 : 4" 06 : 6" 08 : 8" 10 : 10" 12 : 12" SS : Special	<div style="text-align: center;">□□</div> <div style="text-align: center;">↓</div> Body Flame Element C : Carbon Steel 4 : 304 S.S 5 : 304L S.S 6 : 316 S.S 7 : 316L S.S A : Aluminum H : Hastelloy® L : Alloy 20 S : Special Material	<div style="text-align: center;">□□</div> <div style="text-align: center;">↓</div> AR : ANSI Class 150 RF AF : ANSI Class 150 FF KR : KS/JIS 10K RF KF : KS/JIS 10K FF NO : NO Drilling SS : Special	<div style="text-align: center;">□</div> <div style="text-align: center;">↓</div> O : No Option J : Steam Jacket T : Temperature Monitoring Sensor (Unprotected side only) B : Temperature Monitoring Sensor (Both sides) S : Special

EXAMPLE

SFG-08-47-AR-0

Means a 8" model SFG with 304 stainless steel body, 316L stainless steel flame element, ANSI Class 150 RF flange drilling and no other option.

► Hastelloy® is the registered trademark of Haynes International, Inc.



SEWON FLAME TRAP

MODEL STA+SFH

Flame Trap with Flame Arrester



SEWON Q&TECH CO.,LTD.

■ HEAD OFFICE/FACTORY

1038-2, CHUNGOK-RI, JUCHON-MYUN, KIMHAE,
KYEONG-NAM, KOREA. 621-840
Tel: +82-55-323-5894~7
Fax: +82-55-323-5898
<http://www.swqt.co.kr>
<http://www.sewon-ind.co.kr>
E-mail: helpdesk@swqt.co.kr

■ SEOUL OFFICE

3FL, 29-13, KARAK-DONG, SONGPA-KU,
SEOUL, KOREA. 138-160
Tel: +82-2-406-5013~4/406-7021
Fax: +82-2-406-7022
E-mail: helpdesk@swqt.co.kr

MODEL STA+SFH FLAME TRAP with Flame Arrester

Sewon Flame Trap

NOMINAL SIZE

- 2", 2-1/2", 3", 4", 6", 8", 10" and 12"
- Other sizes are available upon request

CONNECTIONS

- ANSI/ASME B16.5 Class 150 Flange
- KS/JIS 10K Flange

The SEWON Flame Trap Assembly combines a spring loaded thermal valve with a flame arrester to prevent flame propagation in the endurance burning condition of low pressure pipe lines.

The spring loaded thermal valve quickly closes when the fusible retainer is melted in the presence of fire. It can be easily monitored the closed position of seat from external view ports. The fusible retainer can be replaced without disassembling entire unit.

Normally, Sewon STA Flame Trap is combined with horizontal flame arrester Sewon Model SFH.



Model STA



Model STA with Flame Arrester SFH(STA+SFH)

SPECIFICATIONS

Installation	Horizontal(recommend)
Melting point of fusible retainer	135deg.c

MATERIALS

PART NAME	MATERIALS	
	STANDARD	OPTIONAL
BODY	CARBON STEEL, 304 S.S, 316 S.S	304L S.S, 316L S.S
DISK	304 S.S, 316 S.S	304L S.S, 316L S.S
SEAT	304 S.S, 316 S.S	304L S.S, 316L S.S

► Other Special materials are available upon customer's request.

DIMENSIONS

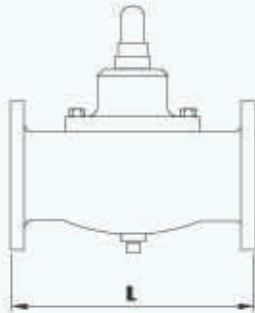

MODEL STA

Size (Inch)	L (mm)	Approx. Weight [Kg]
2"	200	13
2-1/2"	220	21
3"	270	26
4"	330	44
6"	450	78
8"	560	97
10"	670	159
12"	780	210

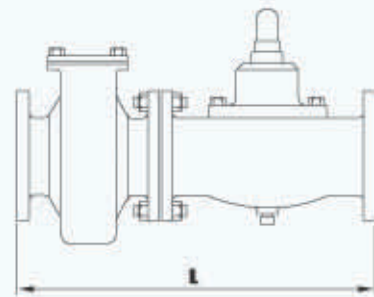

MODEL STA+SFH

Size (Inch)	L (mm)	Approx. Weight [Kg]
2"	400	40
2-1/2"	420	48
3"	480	55
4"	558	86
6"	730	155
8"	930	220
10"	1050	290
12"	1180	350

Actual dimensions may vary from these listed dimensions due to variations or revisions of specifications. The dimensions may change without notice. For more information, consult our factory.

HOW TO ORDER

MODEL	SIZE	MATERIALS	FLANGE DRILLING	OPTION
 STA STA+SFH	 02 : 2" 2A : 2-1/2" 03 : 3" 04 : 4" 06 : 6" 08 : 8" 10 : 10" 12 : 12" SS : Special	 Body Dist & Seat C : Carbon Steel 4 : 304 S.S 5 : 304L S.S 6 : 316 S.S 7 : 316L S.S A : Aluminum S : Special Material	 AR : ANSI Class 150 RF AF : ANSI Class 150 FF KR : KS/JIS 10K RF KF : KS/JIS 10K FF NO : NO Drilling SS : Special	 O : No Option S : Special

EXAMPLE

STA+SFH-06-46-AR-0

Means a 6" model STA+SFH with 304 stainless steel body, 316 stainless seat & disk, ANSI Class 150 RF flange drilling and no other option.

SEWON BREATHER VALVE (Pressure/Vacuum Relief Valve)

- Weight loaded conventional relief valve
- Spring loaded conventional relief valve

END-OF-LINE TYPE

SBF	Pressure & vacuum relief
SBG	Pressure relief
SBV	Vacuum relief
SBFV	Vacuum relief
SBE	Pressure & vacuum relief with steam jacket

IN-LINE TYPE

SBB	Pressure & vacuum relief
SBD	Pressure relief

VALVES FOR SPECIAL APPLICATION



SEWON Q&TECH CO.,LTD.

HEAD OFFICE/FACTORY

1038-2, CHUNGOK-RI, JUCHON-MYUN, KIMHAE,
KYEONG-NAM, KOREA. 621-840
Tel: +82-55-323-5894~7
Fax: +82-55-323-5898
<http://www.swqt.co.kr>
<http://www.sewon-ind.co.kr>
E-mail: helpdesk@swqt.co.kr

SEOUL OFFICE

3FL, 29-13, KARAK-DONG, SONGPA-KU,
SEOUL, KOREA. 138-160
Tel: +82-2-406-5013~4/406-7021
Fax: +82-2-406-7022
E-mail: helpdesk@swqt.co.kr

BREATHER VALVES

Sewon Conventional Breather Valve

Sewon Q&Tech Co., Ltd. manufacture an extensive range of products to protect low pressure storage tanks and pressure vessels.

Sewon pressure and/or vacuum relief valves (Breather valves) are designed to protect storage tank from excessive pressure and/or vacuum.

When a tank is being filled, the vapor that filled the space above the liquid surface is compressed and if this pressure were allowed to exceed the storage tank design pressure, then it would explode or rupture. In addition, if the temperature of the storage tank or vessel increases, then expansion and vaporization may cause the pressure to rise. Conversely, emptying liquid from tank, or a decrease of temperature, cause a vacuum to be created.



Venting requirements are given for flowing conditions, but other circumstances such as pressure transfer blow-off, effect of internal or external heat transfer device, and utility failure should be considered.

- 1) Inbreathing resulting from maximum outflow of liquid from tank
- 2) Inbreathing resulting from contraction or condensation of vapors caused by maximum decreased in vapor space temperature(thermal breathing)
- 3) Outbreathing resulting from maximum inflow of liquid into the tank and maximum vaporization caused by such inflow
- 4) Outbreathing resulting from expansion and vaporization that result from maximum increase in vapor space temperature
- 5) Outbreathing results from fire exposure

Sewon pressure and/or vacuum relief valves may be combined with SEWON flame arrester to prevent explosion of flammable vapors in the storage tank caused by external potential ignition source.

MODEL SBF

Sewon Conventional Breather Valve

NOMINAL SIZE

- 1-1/2", 2", 3", 4", 6", 8", 10", and 12"

CONNECTIONS

- ANSI/ASME B16.5 Class 150 Flange
- KS/JIS 10K Flange

Available in a full range of sizes and configurations, and standard air-cushioned pallet assures minimal internal vapor leakage. FEP TEFLON® seat diaphragms are standard to increase reliability and extended service life, and make minimize sticking caused by resinous vapors and atmospheric moisture.

Guided pressure and vacuum pallets assure smooth lift and closure, and suitable materials available for corrosive and extreme temperature service.



Drilling conforming to ANSI/ASME B16.5 for Class 150 Flanges, or KS/JIS 10K Flanges. Other standards are available on customer's request. Consult our factory for special application or special design.



SPECIFICATIONS

Service	Pressure and Vacuum Relief, End-of-line
Set pressure & set vacuum, min/max	
Weight loaded type	22mmH ₂ O(0.5oz/sq. in) / 700mmH ₂ O(1psi)
Spring loaded type	700mmH ₂ O(1psi) / 1.05kg/cm ² (15psi)
Temperature range(standard)	-45°C ~ 120°C (-50°F ~ +220°F)

MATERIALS

PART NAME	MATERIALS	
	STANDARD	OPTIONAL
BODY & COVER	CARBON STEEL, 304 S.S, 316 S.S, ALUMINUM	HASTELLOY®, ALLOY 20, FRP, PTFE, ETFE LINED
SEAT	304 S.S, 316 S.S, ALUMINUM	HASTELLOY®, ALLOY 20, FRP, PTFE, ETFE LINED
PALLET	304 S.S, 316 S.S	HASTELLOY®, ALLOY 20, FRP, PTFE, ETFE LINED
PALLET GUIDE	304 S.S, 316 S.S	316 S.S, PTFE COATING
SEATING DIAPHRAGM	FEP TEFLON®(Weight loaded type) VITON® O-ring (Spring loaded type)	METAL TO METAL
WEATHER HOOD	304 S.S ALUMINUM	316 S.S

► Other Special materials and special specifications are available upon customer's request.

FLOW CAPACITY

	WEIGHT LOADED	SPRING LOADED
PRESSURE	DATA SHEET NO. BVFL-01	DATA SHEET NO. BVFL-05
VACUUM	DATA SHEET NO. BVFL-02	DATA SHEET NO. BVFL-06

MODEL SBG

Sewon Conventional Breather Valve

NOMINAL SIZE

- 1-1/2", 2", 3", 4", 6", 8", 10", and 12"

CONNECTIONS

- ANSI/ASME B16.5 Class 150 Flange
- KS/JIS 10K Flange

Designed protect storage tank from internal over-pressure, and standard air-cushioned pallet assures minimal internal vapor leakage

NBR(Buna-N), VITON[®] and other seating materials are available when required
 Guided pressure and vacuum pallets assure smooth lift and closure Suitable materials available for corrosive and extreme temperature service



SBG, Weight Loaded Type



SBG, Spring Loaded Type

Drilling conforming to ANSI/ASME B16.5 for Class 150 Flanges, or KS/JIS 10K Flanges. Other standards are available on customer's request. Consult our factory for special application or special design.

SPECIFICATIONS

Service	Pressure Relief, End-of-line
Set pressure, min/max	
Weight loaded type	22mmH ₂ O(0.5oz/sq. in) / 700mmH ₂ O(1psi)
Spring loaded type	700mmH ₂ O(1psi) / 1.05kg/cm ² (15psi)
Temperature range(standard)	-45°C ~ 120°C (-50°F ~ +220°F)

MATERIALS

PART NAME	MATERIALS	
	STANDARD	OPTIONAL
BODY	CARBON STEEL, 304 S.S, 316 S.S, ALUMINUM	HASTELLOY [®] , ALLOY 20, FRP, PTFE, ETFE LINED
SEAT	304 S.S, 316 S.S, ALUMINUM	HASTELLOY [®] , ALLOY 20, FRP, PTFE, ETFE LINED
PALLET	304 S.S, 316 S.S	HASTELLOY [®] , ALLOY 20, FRP, PTFE, ETFE LINED
PALLET GUIDE	304 S.S, 316 S.S	316 S.S, PTFE COATING
SEATING DIAPHRAGM	FEP TEFLON [®] (Weight loaded type) VITON [®] O-ring (Spring loaded type)	METAL TO METAL
WEATHER HOOD	304 S.S ALUMINUM	316 S.S

► Other Special materials and special specifications are available upon customer's request.

FLOW CAPACITY

	WEIGHT LOADED	SPRING LOADED
PRESSURE	DATA SHEET NO. BVFL-01	DATA SHEET NO. BVFL-05
VACUUM	-	-

MODEL SBV

Sewon Conventional Breather Valve

NOMINAL SIZE

- 1", 1-1/2", 2", 3", 4", 6", 8", 10", and 12"

CONNECTIONS

- ANSI/ASME B16.5 Class 150 Flange
- KS/JIS 10K Flange

Designed protect storage tank from excessive negative over-pressure
FEP TEFLON[®] seat diaphragms are standard to increase reliability and extended service life, and make minimize sticking caused by resinous vapors and atmospheric moisture

NBR(Buna-N), VITON and other seating materials are available when required
Suitable materials available for corrosive and extreme temperature service

Drilling conforming to ANSI/ASME B 16.5 for Class 150 Flanges.
or KS/JIS 10K Flanges. Other standards are available on customer's request.
Consult our factory for special application or special design.



SPECIFICATIONS

Service	Vacuum Relief, End-of-line
Set vacuum, min/max	22mmH ₂ O(0.5oz/sq. in) / 700mmH ₂ O(1psi)
Temperature range(standard)	-45°C ~ 120°C (-50°F ~ +220°F)

MATERIALS

PART NAME	MATERIALS	
	STANDARD	OPTIONAL
BODY	CARBON STEEL, 304 S.S, 316 S.S, ALUMINUM	HASTELLOY [®] , ALLOY 20, FRP, PTFE, ETFE LINED
SEAT	304 S.S, 316 S.S, ALUMINUM	HASTELLOY [®] , ALLOY 20, FRP, PTFE, ETFE LINED
PALLET	304 S.S, 316 S.S	HASTELLOY [®] , ALLOY 20, FRP, PTFE, ETFE LINED
SPRING	304 S.S, 316 S.S	316 S.S, PTFE COATING
SEATING DIAPHRAGM	FEP TEFLON [®]	METAL TO METAL
WEATHER HOOD	304 S.S ALUMINUM	316 S.S

► Other Special materials and special specifications are available upon customer's request.

FLOW CAPACITY

REFER TO DATA SHEET NO. BVFL-09

MODEL SBFV

Sewon Conventional Breather Valve

NOMINAL SIZE

- 1-1/2", 2", 3", 4", 6", 8", 10", and 12"

CONNECTIONS

- ANSI/ASME B16.5 Class 150 Flange
- KS/JIS 10K Flange

Available in a full range of sizes and configurations
Designed protect storage tank from excessive negative over-pressure,
and standard air-Cushioned pallet assures minimal internal vapor leakage

FEP TEFLON® seat diaphragms are standard to increase reliability
and extended service life, and make minimize sticking
caused by resinous vapors and atmospheric moisture
Guided vacuum pallets assure smooth lift and closure,
and assures reliable operation
Suitable materials available for corrosive and
extreme temperature service

Drilling conforming to ANSI/ASME B 16.5 for
Class 150 Flanges, or KS/JIS 10K Flanges.
Other standards are available on customer's request.
Consult our factory for special application or special design.



SPECIFICATIONS

Service	Vacuum Relief, End-of-line
Set vacuum, min/max	
Weight loaded type(standard)	22mmHzO(0.5oz/sq. in) / 700mmHzO(1psi)
Spring loaded type	700mmHzO(1psi) / FULL VACUUM
Temperature range(standard)	-45°C ~ 120°C (-50°F ~ +220°F)

MATERIALS

PART NAME	MATERIALS	
	STANDARD	OPTIONAL
BODY & COVER	CARBON STEEL, 304 S.S, 316 S.S, ALUMINUM	HASTELLOY®, ALLOY 20, FRP, PTFE, ETFE LINED
SEAT	304 S.S, 316 S.S, ALUMINUM	HASTELLOY®, ALLOY 20, FRP, PTFE, ETFE LINED
PALLET	304 S.S, 316 S.S	HASTELLOY®, ALLOY 20, FRP, PTFE, ETFE LINED
PALLET GUIDE	304 S.S, 316 S.S	316 S.S, PTFE COATING
SEATING DIAPHRAGM	FEP TEFLON® (Weight loaded type) VITON® O-ring (Spring loaded type)	METAL TO METAL

► Other Special materials and special specifications are available upon customer's request.

FLOW CAPACITY

	WEIGHT LOADED	SPRING LOADED
PRESSURE	-	-
VACUUM	DATA SHEET NO. BVFL-02	DATA SHEET NO. BVFL-06

MODEL SBE

Sewon Conventional Breather Valve

NOMINAL SIZE

- 1-1/2", 2", 3", 4", 6", 8", 10", and 12"

CONNECTIONS

- ANSI/ASME B16.5 Class 150 Flange
- KS/JIS 10K Flange

Installed the steam jacket as standard equipment, and provides a means of transferring heat from steam to the vent. Used on tanks containing liquids whose vapors tend to crystallize at ambient temperatures.

304 stainless steel, and weather hood 304 S.S jacket are standard. Standard air-cushioned pallet assures minimal internal vapor leakage. Guided pressure and vacuum pallets assure smooth lift and closure, and suitable materials available for corrosive and extreme temperature service.



Jacket connection are ANSI/ASME B 16.5 for Class 150 Flanges. Hydrostatic testing can be done in accordance with the customer's request. Threaded connections are also available.



SPECIFICATIONS

Service	Pressure and Vacuum Relief, End-of-line
Set pressure & set vacuum, min/ max	22mmH ₂ O(0.5oz/sq. in) / 700mmH ₂ O(1psi)
Temperature range(standard)	-45°C ~ 120°C (-50°F ~ +220°F)

MATERIALS

PART NAME	MATERIALS	
	STANDARD	OPTIONAL
BODY & COVER	CARBON STEEL, 304 S.S, 316 S.S, ALUMINUM	HASTELLOY [®] , ALLOY 20, FRP, PTFE, ETFE LINED
SEAT	304 S.S, 316 S.S; ALUMINUM	HASTELLOY [®] , ALLOY 20, FRP, PTFE, ETFE LINED
PALLET	304 S.S, 316 S.S	HASTELLOY [®] , ALLOY 20, FRP, PTFE, ETFE LINED
PALLET GUIDE	304 S.S, 316 S.S	316 S.S
SEATING DIAPHRAGM	FEP TEFLON [®]	METAL TO METAL
WEATHER HOOD	304 S.S ALUMINUM	316 S.S

► Other Special materials and special specifications are available upon customer's request.

FLOW CAPACITY

	WEIGHT LOADED	SPRING LOADED
PRESSURE	DATA SHEET NO. BVFL-01	DATA SHEET NO. BVFL-05
VACUUM	DATA SHEET NO. BVFL-02	DATA SHEET NO. BVFL-06

MODEL SBB

Sewon Conventional Breather Valve

NOMINAL SIZE

- 1-1/2", 2", 3", 4", 6", 8", 10", and 12"

CONNECTIONS

- ANSI/ASME B16.5 Class 150 Flange
- KS/JIS 10K Flange

Available in a full range of sizes and configurations

FEP TEFLON[®] seat diaphragms are standard to increase reliability and extended service life, and make minimize sticking caused by resinous vapors and atmospheric moisture

Guided pressure and vacuum pallets assure smooth lift and closure, and suitable materials available for corrosive and extreme temperature service



SBB, Weight Loaded Type



SBB, Spring Loaded

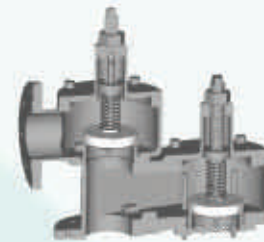

SBB, Dual Spring Loaded Type

Drilling conforming to ANSI/ASME B 16.5 for Class 150 Flanges, or KS/JIS 10K Flanges.

Other standards are available on customer's request. Consult our factory for special application or special design.

SPECIFICATIONS

Service	Pressure and Vacuum Relief, In-line
Set pressure & set vacuum, min/max	
Weight loaded type	22mmH ₂ O(0.5oz/sq. in) / 700mmH ₂ O(1psi)
Spring loaded type	700mmH ₂ O(1psi) / 1.05kg/cm ² (15psi)
Temperature range(standard)	-45°C ~ 120°C (-50°F ~ +220°F)

MATERIALS

PART NAME	MATERIALS	
	STANDARD	OPTIONAL
BODY & COVER	CARBON STEEL, 304 S.S, 316 S.S, ALUMINUM	HASTELLOY [®] , ALLOY 20, FRP, PTFE, ETFE LINED
SEAT	304 S.S, 316 S.S, ALUMINUM	HASTELLOY [®] , ALLOY 20, FRP, PTFE, ETFE LINED
PALLET	304 S.S, 316 S.S	HASTELLOY [®] , ALLOY 20, FRP, PTFE, ETFE LINED
PALLET GUIDE	304 S.S, 316 S.S	316 S.S, PTFE COATING
SEATING DIAPHRAGM	FEP TEFLON [®] (Weight loaded type) VITON [®] O-ring (Spring loaded type)	METAL TO METAL

► Other Special materials and special specifications are available upon customer's request.

FLOW CAPACITY

	WEIGHT LOADED	SPRING LOADED
PRESSURE	DATA SHEET NO. BVFL-03	DATA SHEET NO. BVFL-07
VACUUM	DATA SHEET NO. BVFL-04	DATA SHEET NO. BVFL-08

MODEL SBD

Sewon Conventional Breather Valve

NOMINAL SIZE

- 1", 1-1/2", 2", 3", 4", 6", 8", 10", and 12"

CONNECTIONS

- ANSI/ASME B16.5 Class 150 Flange
- KS/JIS 10K Flange

Available in a full range of sizes and configurations, and a more compact design reduces installation and maintenance cost

FEP TEFLON[®] seat diaphragms are Standard to increase reliability and extended service life, and make minimize sticking caused by resinous vapors and atmospheric moisture

Pipe-away relieves vapors through a flanged connection, and suitable for corrosive and toxic applications



SBD, Weight Loaded Type



SBD, Spring Loaded Type

Drilling conforming to ANSI/ASME B 16.5 for Class 150 Flanges, or KS/JIS 10K Flanges. Other standards are available on customer's request. Consult our factory for special application or special design.



SPECIFICATIONS

Service	Pressure Relief, In-line
Set pressure min/ max	
Weight loaded type	22mmH ₂ O(0.5oz/sq. in) / 700mmH ₂ O(1psi)
Spring loaded type	700mmH ₂ O(1psi) / 1.05kg/cm ² (15psi)
Temperature range(standard)	-45°C ~ 120°C (-50°F ~ +220°F)

MATERIALS

PART NAME	MATERIALS	
	STANDARD	OPTIONAL
BODY & COVER	CARBON STEEL, 304 S.S, 316 S.S, ALUMINUM	HASTELLOY [®] , ALLOY 20, FRP, PTFE, ETFE LINED
SEAT	304 S.S, 316 S.S, ALUMINUM	HASTELLOY [®] , ALLOY 20, FRP, PTFE, ETFE LINED
PALLET	304 S.S, 316 S.S	HASTELLOY [®] , ALLOY 20, FRP, PTFE, ETFE LINED
PALLET GUIDE	304 S.S, 316 S.S	316 S.S, PTFE COATING
SEATING DIAPHRAGM	FEP TEFLON [®] (Weight loaded type) VITON [®] O-ring (Spring loaded type)	METAL TO METAL

► Other Special materials and special specifications are available upon customer's request.

FLOW CAPACITY

	WEIGHT LOADED	SPRING LOADED
PRESSURE	DATA SHEET NO. BVFL-01	DATA SHEET NO. BVFL-05
VACUUM	DATA SHEET NO. BVFL-02	DATA SHEET NO. BVFL-06

SPECIAL APPLICATION

Sewon Conventional Breather Valve

NOMINAL SIZE

- 2", 3", 4", 6", 8", 10", and 12"

CONNECTIONS

- ANSI/ASME B16.5 Class 150 Flange
- KS/JIS 10K Flange

Materials are suitable for corrosive and toxic applications such as hydrochloric acid, sulfuric acid(H_2SO_4) and nitric acid(HNO_3) storage tanks

Customized design service available

Pipe-away relieves vapors through a flanged connection

Compact design reduces installation and maintenance cost



Pressure and vacuum relief valves
with FRP body



Pressure and vacuum relief valve
with Teflon[®] body

Drilling conforming to ANSI/ASME B 16.5 for Class 150 Flanges, or KS/JIS 10K Flanges. Other standards are available on customer's request. Consult our factory for special application or special design.

SPECIFICATIONS

Service

Set pressure & set vacuum, min/ max

Weight loaded type

Spring loaded type

Pressure and Vacuum Relief, In-line

22mmH₂O(0.5oz/sq. in) / 700mmH₂O(1psi)

700mmH₂O(1psi) / 1.05kg/cm²(15psi)

Teflon[®] is registered trademark of the DuPont Company.

Viton[®] is registered trademark of DuPont Dow Elastomers.

END-OF-LINE PRESSURE RELIEF

Set Pressure		Air Flow Rates at 100% overpressure (Double of Set Pressure) in 1,000 Nm ³ /h						
mmH ₂ O	mbar	2"	3"	4"	6"	8"	10"	12"
22	2.2	0.204	0.397	0.747	1.636	2.519	4.112	5.867
25	2.5	0.215	0.419	0.790	1.732	2.666	4.355	6.212
50	4.9	0.298	0.583	1.101	2.425	3.728	6.109	8.706
75	7.4	0.363	0.716	1.351	2.979	4.578	7.503	10.687
100	9.8	0.420	0.827	1.560	3.440	5.284	8.654	12.323
125	12	0.467	0.923	1.740	3.835	5.890	9.640	13.724
150	15	0.509	1.008	1.899	4.183	6.424	10.509	14.959
175	17	0.547	1.085	2.042	4.497	6.907	11.295	16.075
200	20	0.583	1.154	2.174	4.785	7.351	12.017	17.102
225	22	0.615	1.219	2.296	5.053	7.764	12.691	18.06
250	25	0.646	1.281	2.410	5.304	8.152	13.325	18.962
275	27	0.675	1.337	2.519	5.543	8.520	13.925	19.817
300	29	0.703	1.392	2.621	5.768	8.870	14.496	20.63
325	32	0.729	1.444	2.720	5.984	9.204	15.041	21.407
350	34	0.754	1.494	2.813	6.190	9.522	15.563	22.151
375	37	0.779	1.541	2.903	6.387	9.828	16.062	22.864
400	39	0.803	1.587	2.990	6.577	10.121	16.540	23.548
450	44	0.846	1.672	3.151	6.933	10.672	17.441	24.835
500	49	0.887	1.750	3.300	7.262	11.180	18.271	26.023
550	54	0.925	1.824	3.438	7.565	11.649	19.035	27.121
600	59	0.959	1.892	3.564	7.846	12.082	19.741	28.134
700	69	1.021	2.012	3.791	8.346	12.850	20.992	29.937

Notes

- Flow rates listed in above Table are based on full open valves at 100% overpressure.
- If the set pressure is not listed above Table, use liner interpolation.
- If the overpressure is less than 100%, calculate the flow rates using the Factor "C"

Example of Flow Rate Calculation

Model SBF 10"

Set pressure(P_{set})=150mmH₂O(15mbar)

Valve inlet pressure(P_{in})=185mmH₂O

- Calculate overpressure

$$\text{Overpressure} = \frac{P_{in} - P_{set}}{P_{set}} \times 100 = 23(\%)$$

- Determine Factor C from right Table C=0.54

- Read flow rate at 100% overpressure corresponding specified set pressure. The flow rate is 10,509Nm³/h from above Table.

- Calculate flow rate at specified inlet pressure Flow rate at 185mmH₂O=0.54 × 10,509=5,674.9Nm³/h

%	Factor C for less than 100% over-pressure									
	0	1	2	3	4	5	6	7	8	9
10	0.40	0.42	0.43	0.45	0.46	0.47	0.48	0.49	0.50	0.51
20	0.52	0.53	0.53	0.54	0.55	0.56	0.56	0.57	0.58	0.58
30	0.59	0.60	0.60	0.61	0.62	0.62	0.63	0.64	0.64	0.65
40	0.66	0.66	0.67	0.67	0.68	0.69	0.69	0.70	0.70	0.71
50	0.72	0.72	0.73	0.73	0.74	0.75	0.75	0.76	0.76	0.77
60	0.78	0.78	0.79	0.79	0.80	0.80	0.81	0.82	0.82	0.83
70	0.83	0.84	0.84	0.85	0.86	0.86	0.87	0.87	0.88	0.88
80	0.89	0.89	0.90	0.90	0.91	0.91	0.92	0.93	0.93	0.94
90	0.94	0.95	0.95	0.96	0.96	0.97	0.97	0.98	0.98	0.99

VALVE CAPACITY & SIZING

**SBF/SBFV,
Weight loaded**

Sheet No.: BVFL-02

Model SBF / SBFV, Weight Loaded Type

END-OF-LINE VACUUM RELIEF

Set Vacuum		Air Flow Rates at 100% negative overpressure (Double of Set Vacuum) in 1,000 Nm ³ /h						
mmH ₂ O	mbar	2"	3"	4"	6"	8"	10"	12"
-22	-2.2	0.135	0.294	0.457	0.994	1.737	2.614	3.702
-25	-2.5	0.143	0.311	0.484	1.054	1.839	2.768	3.918
-50	-4.9	0.197	0.439	0.680	1.482	2.578	3.889	5.489
-75	-7.4	0.245	0.540	0.838	1.822	3.171	4.780	6.749
-100	-9.8	0.284	0.624	0.969	2.105	3.664	5.519	7.797
-125	-12	0.319	0.696	1.083	2.347	4.087	6.155	8.700
-150	-15	0.350	0.759	1.181	2.560	4.462	6.718	9.498
-175	-17	0.377	0.816	1.271	2.755	4.801	7.230	10.222
-200	-20	0.402	0.869	1.353	2.934	5.113	7.701	10.889
-225	-22	0.425	0.918	1.430	3.100	5.404	8.143	11.512
-250	-25	0.447	0.965	1.502	3.257	5.678	8.559	12.098
-275	-27	0.467	1.009	1.570	3.407	5.938	8.954	12.654
-300	-29	0.486	1.051	1.635	3.550	6.186	9.331	13.183
-325	-32	0.504	1.091	1.697	3.685	6.423	9.692	13.688
-350	-34	0.522	1.129	1.758	3.816	6.650	10.036	14.172
-375	-37	0.538	1.167	1.815	3.941	6.867	10.366	14.635
-400	-39	0.554	1.202	1.870	4.060	7.066	10.683	15.080
-450	-44	0.584	1.269	1.974	4.287	7.469	11.280	15.917
-500	-49	0.612	1.331	2.070	4.496	7.834	11.830	16.689
-550	-54	0.638	1.389	2.160	4.689	8.171	12.338	17.402
-600	-59	0.664	1.442	2.243	4.868	8.483	12.806	18.061
-700	-69	0.710	1.538	2.393	5.186	9.040	13.639	19.232

Notes

- Flow rates listed in above Table are based on full open valves at 100% negative overpressure.
- If the set vacuum is not listed above Table, use liner interpolation.
- If the negative overpressure is less than 100%, calculate the flow rates using the Factor "C"

Example of Flow Rate Calculation

Model SBF 8"

Set vacuum(P_{set})=-200mmH₂O(-20mbar)

Valve inlet pressure(P_{in})=-270mmH₂O

- Calculate overpressure

$$\text{Overpressure} = \frac{P_{in} - P_{set}}{P_{set}} \times 100 = 35(\%)$$

- Determine Factor C from right Table C=0.62

- Read flow rate at 100%

negative overpressure corresponding specified set vacuum. The flow rate is 5,113Nm³/h from above Table.

- Calculate flow rate at specified inlet pressure Flow rate at -270mmH₂O=0.62 × 5,113=3,170Nm³/h

Factor C for less than 100% negative over-pressure

%	0	1	2	3	4	5	6	7	8	9
10	0.40	0.42	0.43	0.45	0.46	0.47	0.48	0.49	0.50	0.51
20	0.52	0.53	0.53	0.54	0.55	0.56	0.56	0.57	0.58	0.58
30	0.59	0.60	0.60	0.61	0.62	0.62	0.63	0.64	0.64	0.65
40	0.66	0.66	0.67	0.67	0.68	0.69	0.69	0.70	0.70	0.71
50	0.72	0.72	0.73	0.73	0.74	0.75	0.75	0.76	0.76	0.77
60	0.78	0.78	0.79	0.79	0.80	0.80	0.81	0.82	0.82	0.83
70	0.83	0.84	0.84	0.85	0.86	0.86	0.87	0.87	0.88	0.88
80	0.89	0.89	0.90	0.90	0.91	0.91	0.92	0.93	0.93	0.94
90	0.94	0.95	0.95	0.96	0.96	0.97	0.97	0.98	0.98	0.99

IN-LINE PRESSURE RELIEF

Set Pressure		Air Flow Rates at 100% overpressure (Double of Set Pressure) in 1,000 Nm ³ /h						
mmH ₂ O	mbar	2"	3"	4"	6"	8"	10"	12"
22	2.2	0.193	0.375	0.706	1.487	2.579	3.874	4.979
25	2.5	0.205	0.398	0.748	1.574	2.729	4.101	5.269
50	4.9	0.289	0.559	1.048	2.207	3.823	5.749	7.384
75	7.4	0.358	0.693	1.291	2.716	4.706	7.075	9.086
100	9.8	0.414	0.805	1.495	3.139	5.443	8.180	10.505
125	12	0.463	0.902	1.670	3.504	6.078	9.134	11.727
150	15	0.506	0.988	1.825	3.827	6.642	9.980	12.811
175	17	0.545	1.066	1.966	4.118	7.153	10.747	13.794
200	20	0.581	1.138	2.097	4.387	7.626	11.456	14.700
225	22	0.615	1.205	2.219	4.638	8.068	12.121	15.548
250	25	0.646	1.269	2.334	4.874	8.484	12.749	16.350
275	27	0.676	1.329	2.444	5.099	8.882	13.346	17.113
300	29	0.705	1.388	2.550	5.313	9.261	13.917	17.842
325	32	0.733	1.443	2.651	5.518	9.625	14.464	18.542
350	34	0.760	1.497	2.749	5.715	9.976	14.991	19.215
375	37	0.786	1.551	2.844	5.903	10.312	15.497	19.864
400	39	0.811	1.601	2.935	6.085	10.638	15.985	20.491
450	44	0.859	1.699	3.108	6.431	11.255	16.908	21.678
500	49	0.904	1.792	3.269	6.751	11.831	17.768	22.788
550	54	0.946	1.881	3.421	7.049	12.369	18.571	23.827
600	59	0.986	1.965	3.564	7.327	12.871	19.318	24.796
700	69	1.059	2.120	3.823	7.827	13.781	20.665	26.552

Notes

- Flow rates listed in above Table are based on full open valves at 100% overpressure.
- If the set pressure is not listed above Table, use liner interpolation.
- If the overpressure is less than 100%, calculate the flow rates using the Factor "C"

Example of Flow Rate Calculation

Model SBB 10"

Set pressure(P_{set})=150mmH₂O(15mbar)

Valve inlet pressure(P_{in})=185mmH₂O

- Calculate overpressure

$$\text{Overpressure} = \frac{P_{in} - P_{set}}{P_{set}} \times 100 = 23(\%)$$

- Determine Factor C from right Table C=0.54

- Read flow rate at 100%

overpressure corresponding specified set pressure. The flow rate is 9,980Nm³/h from above Table.

- Calculate flow rate at specified inlet pressure Flow rate at 185mmH₂O=0.54 × 9,980=5,389Nm³/h

Factor C for less than 100% over-pressure										
%	0	1	2	3	4	5	6	7	8	9
10	0.40	0.42	0.43	0.45	0.46	0.47	0.48	0.49	0.50	0.51
20	0.52	0.53	0.53	0.54	0.55	0.56	0.56	0.57	0.58	0.58
30	0.59	0.60	0.60	0.61	0.62	0.62	0.63	0.64	0.64	0.65
40	0.66	0.66	0.67	0.67	0.68	0.69	0.69	0.70	0.70	0.71
50	0.72	0.72	0.73	0.73	0.74	0.75	0.75	0.76	0.76	0.77
60	0.78	0.78	0.79	0.79	0.80	0.80	0.81	0.82	0.82	0.83
70	0.83	0.84	0.84	0.85	0.86	0.86	0.87	0.87	0.88	0.88
80	0.89	0.89	0.90	0.90	0.91	0.91	0.92	0.93	0.93	0.94
90	0.94	0.95	0.95	0.96	0.96	0.97	0.97	0.98	0.98	0.99

IN-LINE VACUUM RELIEF

Set Vacuum		Air Flow Rates at 100% negative overpressure (Double of Set Vacuum) in 1,000 Nm ³ /h						
mmH ₂ O	mbar	2"	3"	4"	6"	8"	10"	12"
-22	-2.2	0.135	0.294	0.457	0.994	1.737	2.614	3.702
-25	-2.5	0.143	0.311	0.484	1.054	1.839	2.768	3.918
-50	-4.9	0.197	0.439	0.680	1.482	2.578	3.889	5.489
-75	-7.4	0.245	0.540	0.838	1.822	3.171	4.780	6.749
-100	-9.8	0.284	0.624	0.969	2.105	3.664	5.519	7.797
-125	-12	0.319	0.696	1.083	2.347	4.087	6.155	8.700
-150	-15	0.350	0.759	1.181	2.560	4.462	6.718	9.498
-175	-17	0.377	0.816	1.271	2.755	4.801	7.230	10.222
-200	-20	0.402	0.869	1.353	2.934	5.113	7.701	10.889
-225	-22	0.425	0.918	1.430	3.100	5.404	8.143	11.512
-250	-25	0.447	0.965	1.502	3.257	5.678	8.559	12.098
-275	-27	0.467	1.009	1.570	3.407	5.938	8.954	12.654
-300	-29	0.486	1.051	1.635	3.550	6.186	9.331	13.183
-325	-32	0.504	1.091	1.697	3.685	6.423	9.692	13.688
-350	-34	0.522	1.129	1.758	3.816	6.650	10.036	14.172
-375	-37	0.538	1.167	1.815	3.941	6.867	10.366	14.635
-400	-39	0.554	1.202	1.870	4.060	7.076	10.683	15.080
-450	-44	0.584	1.269	1.974	4.287	7.469	11.280	15.917
-500	-49	0.612	1.331	2.070	4.496	7.834	11.830	16.689
-550	-54	0.638	1.389	2.160	4.689	8.171	12.338	17.402
-600	-59	0.664	1.442	2.243	4.868	8.483	12.806	18.061
-700	-69	0.710	1.538	2.393	5.186	9.040	13.639	19.232

Notes

1. Flow rates listed in above Table are based on full open valves at 100% negative overpressure.
2. If the set vacuum is not listed above Table, use liner interpolation.
3. If the negative overpressure is less than 100%, calculate the flow rates using the Factor "C"

Example of Flow Rate Calculation

Model SBB 8"

Set vacuum(P_{set})=-200mmH₂O(-20mbar)

Valve inlet pressure(P_{in})=-270mmH₂O

1. Calculate overpressure

$$\text{Overpressure} = \frac{P_{in} - P_{set}}{P_{set}} \times 100 = 35(\%)$$

2. Determine Factor C from right Table C=0.62

3. Read flow rate at 100%

negative overpressure corresponding specified set vacuum. The flow rate is 5,113Nm³/h from above Table.

4. Calculate flow rate at specified inlet pressure Flow rate at -270mmH₂O=0.62 × 5,113=3,170Nm³/h

Factor C for less than 100% negative over-pressure										
%	0	1	2	3	4	5	6	7	8	9
10	0.40	0.42	0.43	0.45	0.46	0.47	0.48	0.49	0.50	0.51
20	0.52	0.53	0.53	0.54	0.55	0.56	0.56	0.57	0.58	0.58
30	0.59	0.60	0.60	0.61	0.62	0.62	0.63	0.64	0.64	0.65
40	0.66	0.66	0.67	0.67	0.68	0.69	0.69	0.70	0.70	0.71
50	0.72	0.72	0.73	0.73	0.74	0.75	0.75	0.76	0.76	0.77
60	0.78	0.78	0.79	0.79	0.80	0.80	0.81	0.82	0.82	0.83
70	0.83	0.84	0.84	0.85	0.86	0.86	0.87	0.87	0.88	0.88
80	0.89	0.89	0.90	0.90	0.91	0.91	0.92	0.93	0.93	0.94
90	0.94	0.95	0.95	0.96	0.96	0.97	0.97	0.98	0.98	0.99

END-OF-LINE PRESSURE RELIEF

Set Pressure		Air Flow Rates at 100% overpressure (Double of Set Pressure) in 1,000 Nm ³ /h						
mmH ₂ O	mbar	2"	3"	4"	6"	8"	10"	12"
700	69	0.822	1.722	3.022	5.927	10.650	15.929	22.252
750	74	0.851	1.766	3.100	6.080	10.930	16.341	22.827
800	78	0.879	1.809	3.177	6.232	11.208	16.752	23.399
850	83	0.907	1.853	3.254	6.384	11.485	17.160	23.969
900	88	0.934	1.897	3.331	6.534	11.761	17.567	24.535
1,000	98	0.987	1.985	3.483	6.834	12.309	18.374	25.661
1,200	118	1.088	2.156	3.783	7.424	13.388	19.968	27.882
1,500	147	1.227	2.408	4.223	8.291	14.967	22.303	31.137
1,750	172	1.333	2.612	4.581	8.995	16.249	24.202	33.783
2,000	196	1.434	2.812	4.932	9.683	17.500	26.058	36.368
2,250	221	1.529	3.007	5.273	10.356	18.722	27.872	38.896
2,500	245	1.619	3.198	5.608	11.014	19.916	29.646	41.368
3,000	294	1.789	3.567	6.256	12.288	22.221	33.078	46.148
3,500	343	1.949	3.920	6.875	13.505	24.422	36.361	50.721
4,000	392	2.100	4.260	7.470	14.672	26.527	39.502	55.097
4,500	441	2.244	4.584	8.039	15.790	28.540	42.510	59.287
5,000	490	2.383	4.894	8.584	16.860	30.467	45.391	63.301
5,500	539	2.517	5.192	9.107	17.886	32.313	48.151	67.148
6,000	588	2.647	5.476	9.609	18.870	34.084	50.796	70.836
7,000	686	2.894	6.012	10.554	20.723	37.414	55.767	77.769
10,000	980	3.553	7.382	12.980	25.473	45.983	68.469	95.528
10,500	1,029	3.652	7.581	13.334	26.164	47.236	70.310	98.108

Notes

- Flow rates listed in above Table are based on full open valves at 100% overpressure.
- If the set pressure is not listed above Table, use liner interpolation.
- If the overpressure is less than 100%, calculate the flow rates using the Factor "C"

Example of Flow Rate Calculation

Model SBF 4", Spring loaded

Set pressure(P_{set})=2,000mmH₂O(196mbar)

Valve inlet pressure(P_{in})=3,200mmH₂O

- Calculate overpressure

$$\text{Overpressure} = \frac{P_{in} - P_{set}}{P_{set}} \times 100 = 60(\%)$$

- Determine Factor C from right Table C=0.71

- Read flow rate at 100% overpressure corresponding specified set pressure. The flow rate is 4,932Nm³/h from above Table.

- Calculate flow rate at specified inlet pressure Flow rate at 3,200mmH₂O=0.71 × 4,932=3,501Nm³/h

%	Factor C for less than 100% over-pressure									
	0	1	2	3	4	5	6	7	8	9
10	-	-	-	-	-	0.20	0.21	0.23	0.24	0.25
20	0.27	0.28	0.29	0.31	0.32	0.33	0.35	0.36	0.37	0.39
30	0.40	0.41	0.42	0.43	0.45	0.46	0.47	0.48	0.49	0.50
40	0.51	0.52	0.53	0.54	0.56	0.57	0.58	0.59	0.60	0.61
50	0.62	0.62	0.63	0.64	0.65	0.66	0.67	0.68	0.69	0.70
60	0.71	0.72	0.72	0.73	0.74	0.75	0.76	0.77	0.77	0.78
70	0.79	0.80	0.81	0.81	0.82	0.83	0.84	0.84	0.85	0.86
80	0.87	0.87	0.88	0.89	0.89	0.90	0.91	0.91	0.92	0.93
90	0.93	0.94	0.95	0.95	0.96	0.97	0.97	0.98	0.99	0.99

VALVE CAPACITY & SIZING

**SBF/SBFV,
Spring loaded**

Sheet No.: BVFL-06 Model SBF / SBFV, Spring Loaded Type

END-OF-LINE VACUUM RELIEF

Set Vacuum		Air Flow Rates at 100% negative overpressure (Double of Set Vacuum) in 1,000 Nm ³ /h						
mmH ₂ O	mbar	2"	3"	4"	6"	8"	10"	12"
-700	-69	0.395	0.864	1.491	3.387	5.554	8.544	11.902
-750	-74	0.407	0.892	1.539	3.495	5.732	8.816	12.290
-800	-78	0.420	0.919	1.585	3.600	5.906	9.081	12.666
-850	-83	0.432	0.945	1.631	3.703	6.074	9.339	13.031
-900	-88	0.443	0.971	1.675	3.803	6.238	9.590	13.384
-950	-93	0.455	0.995	1.718	3.900	6.398	9.834	13.728
-1,000	-98	0.466	1.019	1.759	3.994	6.554	10.072	14.061
-1,100	-108	0.487	1.066	1.840	4.176	6.852	10.528	14.699
-1,200	-118	0.507	1.109	1.916	4.348	7.135	10.959	15.300
-1,300	-127	0.525	1.151	1.988	4.511	7.403	11.368	15.869
-1,400	-137	0.543	1.190	2.056	4.665	7.657	11.755	16.406
-1,500	-147	0.560	1.227	2.120	4.811	7.897	12.122	16.915
-1,600	-157	0.576	1.262	2.182	4.950	8.125	12.469	17.397
-1,700	-167	0.591	1.296	2.240	5.081	8.341	12.798	17.855
-1,800	-176	0.605	1.327	2.295	5.206	8.545	13.109	18.289
-1,900	-186	0.619	1.357	2.347	5.324	8.738	13.404	18.702
-2,000	-196	0.631	1.385	2.396	5.436	8.922	13.683	19.096
-2,100	-206	0.643	1.412	2.443	5.541	9.095	13.947	19.470
-2,200	-216	0.655	1.437	2.487	5.642	9.260	14.197	19.827
-2,300	-225	0.665	1.461	2.529	5.737	9.415	14.434	20.168
-2,400	-235	0.675	1.484	2.569	5.827	9.563	14.658	20.494
-2,500	-245	0.685	1.505	2.607	5.912	9.703	14.871	20.806

Notes

- Flow rates listed in above Table are based on full open valves at 100% negative overpressure.
- If the set vacuum is not listed above Table, use liner interpolation.
- If the negative overpressure is less than 100%, calculate the flow rates using the Factor "C"

Example of Flow Rate Calculation

Model SBF 8", Spring loaded

Set vacuum(P_{set})=-850mmH₂O(-83mbar)

Valve inlet pressure(P_{in})=-1,000mmH₂O

- Calculate overpressure

$$\text{Overpressure} = \frac{P_{in} - P_{set}}{P_{set}} \times 100 = 18(\%)$$

- Determine Factor C from right Table C=0.24

- Read flow rate at 100% negative overpressure corresponding specified set vacuum. The flow rate is 6,074Nm³/h from above Table.

- Calculate flow rate at specified inlet pressure Flow rate at -1,000mmH₂O=0.24 × 6,074=1,458Nm³/h

Factor C for less than 100% negative over-pressure

%	0	1	2	3	4	5	6	7	8	9
10	-	-	-	-	-	0.20	0.21	0.23	0.24	0.25
20	0.27	0.28	0.29	0.31	0.32	0.33	0.35	0.36	0.37	0.39
30	0.40	0.41	0.42	0.43	0.45	0.46	0.47	0.48	0.49	0.50
40	0.51	0.52	0.53	0.54	0.56	0.57	0.58	0.59	0.60	0.61
50	0.62	0.62	0.63	0.64	0.65	0.66	0.67	0.68	0.69	0.70
60	0.71	0.72	0.72	0.73	0.74	0.75	0.76	0.77	0.77	0.78
70	0.79	0.80	0.81	0.81	0.82	0.83	0.84	0.84	0.85	0.86
80	0.87	0.87	0.88	0.89	0.89	0.90	0.91	0.91	0.92	0.93
90	0.93	0.94	0.95	0.95	0.96	0.97	0.97	0.98	0.99	0.99

IN-LINE PRESSURE RELIEF

Set Pressure		Air Flow Rates at 100% overpressure (Double of Set Pressure) in 1,000 Nm ³ /h						
mmH ₂ O	mbar	2"	3"	4"	6"	8"	10"	12"
700	69	0.822	1.609	2.878	6.585	10.650	15.929	22.252
750	74	0.851	1.650	2.952	6.755	10.930	16.341	22.827
800	78	0.879	1.691	3.026	6.924	11.208	16.752	23.399
850	83	0.907	1.732	3.099	7.093	11.485	17.160	23.969
900	88	0.934	1.773	3.172	7.260	11.761	17.567	24.535
1,000	98	0.987	1.855	3.317	7.593	12.309	18.374	25.661
1,200	118	1.088	2.015	3.603	8.249	13.388	19.968	27.882
1,500	147	1.227	2.250	4.022	9.212	14.967	22.303	31.137
1,750	172	1.333	2.441	4.363	9.994	16.249	24.202	33.783
2,000	196	1.434	2.628	4.697	10.759	17.500	26.058	36.368
2,250	221	1.529	2.810	5.022	11.507	18.722	27.872	38.896
2,500	245	1.619	2.989	5.341	12.238	19.916	29.646	41.368
3,000	294	1.789	3.334	5.958	13.653	22.221	33.078	46.148
3,500	343	1.949	3.664	6.548	15.006	24.422	36.361	50.721
4,000	392	2.100	3.981	7.114	16.302	26.527	39.502	55.097
4,500	441	2.244	4.284	7.656	17.544	28.540	42.510	59.287
5,000	490	2.383	4.574	8.175	18.733	30.467	45.391	63.301
5,500	539	2.517	4.852	8.673	19.873	32.313	48.151	67.148
6,000	588	2.647	5.118	9.151	20.967	34.084	50.796	70.836
7,000	686	2.894	5.619	10.051	23.025	37.414	55.767	77.769
10,000	980	3.553	6.899	12.362	28.303	45.983	68.469	95.528
10,500	1,029	3.652	7.085	12.699	29.071	47.236	70.310	98.108

Notes

- Flow rates listed in above Table are based on full open valves at 100% overpressure.
- If the set pressure is not listed above Table, use liner interpolation.
- If the overpressure is less than 100%, calculate the flow rates using the Factor "C"

Example of Flow Rate Calculation

Model SBB 4", Spring loaded

Set pressure(P_{set})=1,200mmH₂O(118mbar)

Valve inlet pressure(P_{in})=1,700mmH₂O

- Calculate overpressure

$$\text{Overpressure} = \frac{P_{in} - P_{set}}{P_{set}} \times 100 = 42(\%)$$

- Determine Factor C from right Table C=0.53

- Read flow rate at 100% overpressure corresponding specified set pressure. The flow rate is 3,603Nm³/h from above Table.

- Calculate flow rate at specified inlet pressure Flow rate at 1,700mmH₂O=0.53 × 3,603=1,910Nm³/h

%	Factor C for less than 100% over-pressure									
	0	1	2	3	4	5	6	7	8	9
10	-	-	-	-	-	0.20	0.21	0.23	0.24	0.25
20	0.27	0.28	0.29	0.31	0.32	0.33	0.35	0.36	0.37	0.39
30	0.40	0.41	0.42	0.43	0.45	0.46	0.47	0.48	0.49	0.50
40	0.51	0.52	0.53	0.54	0.56	0.57	0.58	0.59	0.60	0.61
50	0.62	0.62	0.63	0.64	0.65	0.66	0.67	0.68	0.69	0.70
60	0.71	0.72	0.72	0.73	0.74	0.75	0.76	0.77	0.77	0.78
70	0.79	0.80	0.81	0.81	0.82	0.83	0.84	0.84	0.85	0.86
80	0.87	0.87	0.88	0.89	0.89	0.90	0.91	0.91	0.92	0.93
90	0.93	0.94	0.95	0.95	0.96	0.97	0.97	0.98	0.99	0.99

IN-LINE VACUUM RELIEF

Set Vacuum		Air Flow Rates at 100% negative overpressure (Double of Set Vacuum) in 1,000 Nm ³ /h						
mmH ₂ O	mbar	2"	3"	4"	6"	8"	10"	12"
-700	-69	0.395	0.864	1.491	3.387	5.554	8.544	11.902
-750	-74	0.407	0.892	1.539	3.495	5.732	8.816	12.290
-800	-78	0.420	0.919	1.585	3.600	5.906	9.081	12.666
-850	-83	0.432	0.945	1.631	3.703	6.074	9.339	13.031
-900	-88	0.443	0.971	1.675	3.803	6.238	9.590	13.384
-950	-93	0.455	0.995	1.718	3.900	6.398	9.834	13.728
-1,000	-98	0.466	1.019	1.759	3.994	6.554	10.072	14.061
-1,100	-108	0.487	1.066	1.840	4.176	6.852	10.528	14.699
-1,200	-118	0.507	1.109	1.916	4.348	7.135	10.959	15.300
-1,300	-127	0.525	1.151	1.988	4.511	7.403	11.368	15.869
-1,400	-137	0.543	1.190	2.056	4.665	7.657	11.755	16.406
-1,500	-147	0.560	1.227	2.120	4.811	7.897	12.122	16.915
-1,600	-157	0.576	1.262	2.182	4.950	8.125	12.469	17.397
-1,700	-167	0.591	1.296	2.240	5.081	8.341	12.798	17.855
-1,800	-176	0.605	1.327	2.295	5.206	8.545	13.109	18.289
-1,900	-186	0.619	1.357	2.347	5.324	8.738	13.404	18.702
-2,000	-196	0.631	1.385	2.396	5.436	8.922	13.683	19.096
-2,100	-206	0.643	1.412	2.443	5.541	9.095	13.947	19.470
-2,200	-216	0.655	1.437	2.487	5.642	9.260	14.197	19.827
-2,300	-225	0.665	1.461	2.529	5.737	9.415	14.434	20.168
-2,400	-235	0.675	1.484	2.569	5.827	9.563	14.658	20.494
-2,500	-245	0.685	1.505	2.607	5.912	9.703	14.871	20.806

Notes

- Flow rates listed in above Table are based on full open valves at 100% negative overpressure.
- If the set vacuum is not listed above Table, use liner interpolation.
- If the negative overpressure is less than 100%, calculate the flow rates using the Factor "C"

Example of Flow Rate Calculation

Model SBB 6", Spring loaded

Set vacuum(P_{set})=-900mmH₂O(-88mbar)

Valve inlet pressure(P_{in})=-1,250mmH₂O

- Calculate overpressure

$$\text{Overpressure} = \frac{P_{in} - P_{set}}{P_{set}} \times 100 = 39(\%)$$

- Determine Factor C from right Table C=0.50

- Read flow rate at 100%

negative overpressure corresponding specified set vacuum. The flow rate is 3,803Nm³/h from above Table.

- Calculate flow rate at specified inlet pressure Flow rate at -1,250mmH₂O=0.50 × 3,803=1,902Nm³/h

Factor C for less than 100% negative over-pressure										
%	0	1	2	3	4	5	6	7	8	9
10	-	-	-	-	-	0.20	0.21	0.23	0.24	0.25
20	0.27	0.28	0.29	0.31	0.32	0.33	0.35	0.36	0.37	0.39
30	0.40	0.41	0.42	0.43	0.45	0.46	0.47	0.48	0.49	0.50
40	0.51	0.52	0.53	0.54	0.56	0.57	0.58	0.59	0.60	0.61
50	0.62	0.62	0.63	0.64	0.65	0.66	0.67	0.68	0.69	0.70
60	0.71	0.72	0.72	0.73	0.74	0.75	0.76	0.77	0.77	0.78
70	0.79	0.80	0.81	0.81	0.82	0.83	0.84	0.84	0.85	0.86
80	0.87	0.87	0.88	0.89	0.89	0.90	0.91	0.91	0.92	0.93
90	0.93	0.94	0.95	0.95	0.96	0.97	0.97	0.98	0.99	0.99

END-OF-LINE VACUUM RELIEF

Set Vacuum		Air Flow Rates at 100% negative overpressure (Double of Set Vacuum) in 1,000 Nm ³ /h						
mmH ₂ O	mbar	2"	3"	4"	6"	8"	10"	12"
-22	-2.2	0.125	0.274	0.426	0.927	1.620	2.438	3.453
-25	-2.5	0.132	0.290	0.451	0.983	1.715	2.582	3.654
-50	-4.9	0.183	0.409	0.635	1.382	2.405	3.627	5.119
-75	-7.4	0.226	0.503	0.782	1.700	2.958	4.459	6.294
-100	-9.8	0.262	0.582	0.904	1.963	3.417	5.148	7.272
-125	-12	0.294	0.649	1.009	2.189	3.812	5.741	8.114
-150	-15	0.323	0.708	1.102	2.389	4.162	6.266	8.859
-175	-17	0.348	0.761	1.185	2.569	4.478	6.743	9.534
-200	-20	0.372	0.811	1.262	2.736	4.769	7.183	10.156
-225	-22	0.393	0.857	1.334	2.892	5.040	7.595	10.737
-250	-25	0.413	0.900	1.401	3.038	5.296	7.983	11.284
-275	-27	0.432	0.941	1.465	3.177	5.539	8.352	11.802
-300	-29	0.449	0.980	1.525	3.310	5.770	8.703	12.296
-325	-32	0.466	1.018	1.583	3.437	5.991	9.039	12.767
-350	-34	0.482	1.054	1.639	3.559	6.202	9.360	13.218
-375	-37	0.497	1.088	1.692	3.675	6.405	9.668	13.650
-400	-39	0.512	1.121	1.744	3.787	6.600	9.964	14.065
-450	-44	0.540	1.184	1.841	3.998	6.967	10.520	14.846
-500	-49	0.566	1.242	1.931	4.193	7.307	11.033	15.566
-550	-54	0.590	1.296	2.014	4.373	7.621	11.507	16.231
-600	-59	0.613	1.346	2.092	4.540	7.912	11.944	16.845
-700	-69	0.655	1.435	2.232	4.838	8.431	12.720	17.938

Notes

- Flow rates listed in above Table are based on full open valves at 100% negative overpressure.
- If the set vacuum is not listed above Table, use liner interpolation.
- If the negative overpressure is less than 100%, calculate the flow rates using the Factor "C"

Example of Flow Rate Calculation

Model SBV 4"

Set vacuum(P_{set})=-50mmH₂O(-4.9mbar)

Valve inlet pressure(P_{in})=-80mmH₂O

- Calculate overpressure

$$\text{Overpressure} = \frac{P_{in} - P_{set}}{P_{set}} \times 100 = 60(\%)$$

- Determine Factor C from right Table C=0.71

- Read flow rate at 100% negative overpressure corresponding specified set vacuum. The flow rate is 635Nm³/h from above Table.

- Calculate flow rate at specified inlet pressure Flow rate at -80mmH₂O=0.71 × 635=451Nm³/h

Factor C for less than 100% negative over-pressure										
%	0	1	2	3	4	5	6	7	8	9
10	-	-	-	-	-	0.20	0.21	0.23	0.24	0.25
20	0.27	0.28	0.29	0.31	0.32	0.33	0.35	0.36	0.37	0.39
30	0.40	0.41	0.42	0.43	0.45	0.46	0.47	0.48	0.49	0.50
40	0.51	0.52	0.53	0.54	0.56	0.57	0.58	0.59	0.60	0.61
50	0.62	0.62	0.63	0.64	0.65	0.66	0.67	0.68	0.69	0.70
60	0.71	0.72	0.72	0.73	0.74	0.75	0.76	0.77	0.77	0.78
70	0.79	0.80	0.81	0.81	0.82	0.83	0.84	0.84	0.85	0.86
80	0.87	0.87	0.88	0.89	0.89	0.90	0.91	0.91	0.92	0.93
90	0.93	0.94	0.95	0.95	0.96	0.97	0.97	0.98	0.99	0.99

DIMENSIONS

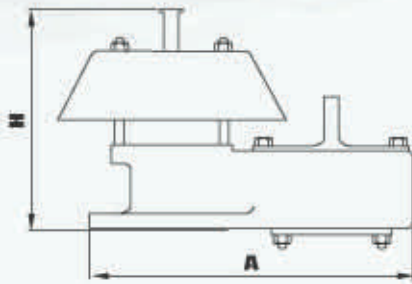

MODEL SBF

Size (inch)	H (mm)	A (mm)	Approx. Weight [Kg] (At Min. Setting)	
			C.S	Aluminum
2"	275	320	9.5	5
3"	300	400	21	8
4"	325	450	32	10
6"	400	590	45	17
8"	475	690	65	24
10"	525	800	84	38
12"	600	930	130	57

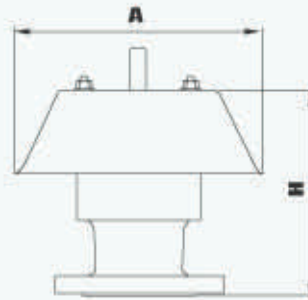

MODEL SBG

Size (inch)	H (mm)	A (mm)	Approx. Weight [Kg] (At Min. Setting)	
			C.S	Aluminum
2"	205	200	12	5
3"	235	270	17	7
4"	270	280	22.5	9
6"	305	345	35	14
8"	350	400	50	20
10"	365	400	75	30
12"	435	500	112	45

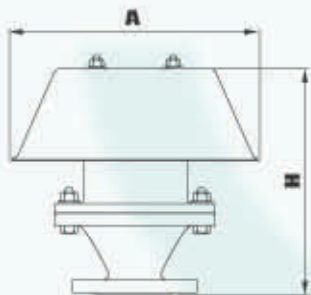

MODEL SBV

Size (inch)	H (mm)	A (mm)	Approx. Weight [Kg] (At Min. Setting)	
			C.S	Aluminum
2"	290	200	12	5
3"	305	270	17	7
4"	350	280	22.5	9
6"	385	345	35	14
8"	395	400	50	20
10"	405	400	75	30
12"	455	500	112	45

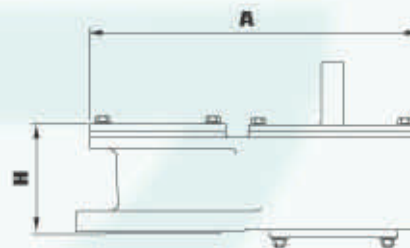

MODEL SBFV

Size (inch)	H (mm)	A (mm)	Approx. Weight [Kg] (At Min. Setting)	
			C.S	Aluminum
2"	110	280	10	6
3"	125	350	22	9
4"	130	410	33	11
6"	165	500	46	18
8"	210	605	66	25
10"	225	715	85	39
12"	260	855	130	58

Actual dimensions may vary from these listed dimensions due to variations or revisions of specifications. The dimensions may change without notice. For more information, consult our factory.

DIMENSIONS

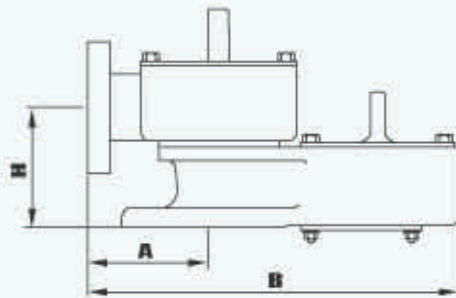

MODEL SBB

Size (inch)	H (mm)	A (mm)	B (mm)	Approx. Weight [Kg] (At Min. Setting)	
				C.S	Aluminum
1"×1"	-	-	-	-	-
2"×2"	145	115	340	18	8
3"×3"	175	145	415	36	13
4"×4"	190	180	495	46	17
6"×6"	235	215	605	77	27
8"×8"	285	300	775	120	43
10"×10"	325	300	860	154	66
12"×12"	400	360	1030	250	93

MODEL SBBU

Size (inch)	H (mm)	A (mm)	B (mm)	Approx. Weight [Kg] (At Min. Setting)	
				C.S	Aluminum
2"×3"	145	115	340	30	12
3"×4"	175	145	415	40	16
4"×6"	190	180	495	55	22
6"×8"	235	215	605	105	42
8"×10"	285	300	775	155	62
10"×12"	325	300	860	210	85
12"×14"	400	360	1030	290	118

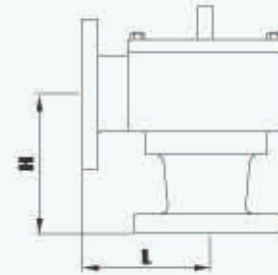

MODEL SBD

Size (inch)	H (mm)	L (mm)	Approx. Weight [Kg] (At Min. Setting)	
			C.S	Aluminum
1"×1"	-	-	-	-
2"×2"	145	115	15	7
3"×3"	175	145	25	10
4"×4"	190	180	33	13
6"×6"	235	215	62	25
8"×8"	285	300	100	42
10"×10"	325	300	120	48
12"×12"	400	360	150	68

MODEL SBDU

Size (inch)	H (mm)	L (mm)	Approx. Weight [Kg] (At Min. Setting)	
			C.S	Aluminum
2"×3"	145	115	20	8
3"×4"	175	145	30	12
4"×6"	190	180	45	18
6"×8"	235	215	75	30
8"×10"	285	300	125	50
10"×12"	325	300	155	62
12"×14"	400	360	202	81

HOW TO ORDER

MODEL	TYPE	INLET SIZE	MATERIALS	FLANGE DRILLING	OPTION
□□□	□	□□	□□□ Pallet Seat Body	□□	□
SBF SBG SBB SBD SBV SBFV SBE SBBU SBDU	W : Weight loaded for P/V sides S : Spring loaded for pressure side V : Spring loaded for vacuum side D : Spring loaded for P/V sides (Dual spring)	01 : 1" 1A : 1-1/2" 02 : 2" 2A : 2-1/2" 03 : 3" 04 : 4" 06 : 6" 08 : 8" 10 : 10" 12 : 12" SS : Special	C : Carbon Steel 4 : 304 S.S 5 : 304L S.S 6 : 316 S.S 7 : 316L S.S A : Aluminum S : Special Material	AR : ANSI Class 150 RF AF : ANSI Class 150 FF KR : KS/JIS 10K RF KF : KS/JIS 10K FF NO : No Drilling SS : Special	O : No Option J : Steam Jacket S : Special

EXAMPLE

SBF-W-02-C44-AR-0

Means a 2" model SBF weight loaded relief valve for pressure & vacuum sides, with carbon steel body, 304 SS seat, 304 SS pallet, ANSI Class 150 RF flange drilling and no other option.

SEWON

PRESSURE/VACUUM RELIEF VALVE with FLAME ARRESTER

END-OF-LINE TYPE

SBF+SFG
SBF+SFH
SBG+SFG

IN-LINE TYPE

SBB+SFG
SBB+SFH
SBD+SFG

SEWON Q&TECH CO.,LTD.

■ **HEAD OFFICE/FACTORY**

1038-2, CHUNGOK-RI, JUCHON-MYUN, KIMHAE,
KYEONG-NAM, KOREA. 621-840
Tel: +82-55-323-5894~7
Fax: +82-55-323-5898
<http://www.swqt.co.kr>
<http://www.sewon-ihd.co.kr>
E-mail: helpdesk@swqt.co.kr

■ **SEOUL OFFICE**

3FL, 29-13, KARAK-DONG, SONGPA-KU,
SEOUL, KOREA. 138-160
Tel: +82-2-406-5013~4/406-7021
Fax: +82-2-406-7022
E-mail: helpdesk@swqt.co.kr



MODEL SBF+SFG, SBB+SFG

Sewon Pressure / Vacuum Relief Valve with Flame Arrester

NOMINAL SIZE

- 2", 3", 4", 6", 8", 10", and 12"
- Available Customized Design

CONNECTIONS

- ANSI/ASME B16.5 Class 150 Flange
- KS/JIS 10K Flange

Combination pressure / vacuum relief valve and flame arrester
Protect storage tank from overpressure or excessive vacuum,
and potential ignition source

Air-cushion pallet reduces the internal vapor leakage

TEFLON[®] seat diaphragms are standard to minimize sticking caused
by resinous vapors and atmospheric moisture

Crimped ribbon flame elements

Drilling conforming to ANSI/ASME B16.5 for class 150 flanges,
or KS/JIS 10K flanges.

other standards are available on customer's request

► Consult our factory for special application or special design.



Model SBB+SFG

SPECIFICATIONS

Installation	Vertical
Model SBF+SFG	End-of-line, vented to the atmosphere directly
Model SBB+SFG	In-line, a flanged side connection is provided For pipe away of vapors
Flame arrester classification	Deflagration flame arrester, Bi-directional
Set pressure / Set vacuum	20mmH ₂ O to 700 mmH ₂ O(Standard specification)
Explosion gas group	IIA(standard), IIB/IIC(for special application)

► Other specifications are available. consult our factory

MATERIALS

PART NAME	MATERIALS	
	STANDARD	OPTIONAL
BODY	CARBON STEEL, 304 S.S, 316 S.S, ALUMINUM	HASTELLOY [®] , ALLOY 20, MONEL, INCONEL
FLAME ELEMENT	304 S.S, 316 S.S	HASTELLOY [®] , ALLOY 20, MONEL, INCONEL
ELEMENT HOUSING	304 S.S, 316 S.S	HASTELLOY [®] , ALLOY 20, MONEL, INCONEL
STUD BOLT AND NUT	C.S, 304 S.S	316 S.S
PALLET	304 S.S, 316 S.S	HASTELLOY [®] , ALLOY 20
SEAT	304 S.S, 316 S.S, ALUMINUM	HASTELLOY [®] , ALLOY 20
SEATING DIAPHRAGM	FEP TEFLON [®] (Weight loaded type) VITON [®] O-ring (Spring loaded type)	METAL TO METAL, VITON
HOOD(MODEL SBF)	304 S.S, ALUMINUM	316 S.S

► Other Special materials such as Hastelloy[®] B/C are available upon customer's request.

MODEL SBF+SFH, SBB+SFH

Sewon Pressure / Vacuum Relief Valve with Flame Arrester

NOMINAL SIZE

- 2", 3", 4", 6", 8", 10", and 12"

CONNECTIONS

- ANSI/ASME B16.5 Class 150 Flange
- KS/JIS 10K Flange

Protect storage tank from overpressure or excessive vacuum, and potential ignition source
Weight loaded for pressure and vacuum venting
Designed easy periodic inspection and maintenance
Air-cushion pallet reduces the internal vapor leakage

TEFLON[®] seat diaphragms are standard to minimize sticking caused by resinous vapors and atmospheric moisture
Crimped ribbon flame elements
Drilling conforming to ANSI/ASME B16.5 for class 150 flanges, or KS/JIS 10K flanges.
Other standards are available on customer's request

► Consult our factory for special application or special design.



Model SBF+SFH



SPECIFICATIONS

Installation	Vertical
Model SBF+SFH	End-of-line, vented to the atmosphere directly
Model SBB+SFH	In-line, a flanged side connection is provided For pipe away of vapors
Flame arrester classification	Deflagration flame arrester, Bi-directional
Set pressure / Set vacuum	20mmH ₂ O to 700 mmH ₂ O(Standard specification)
Explosion gas group	IIA(standard), IIB/IIC(for special application)

► Other specifications are available. consult our factory

MATERIALS

PART NAME	MATERIALS	
	STANDARD	OPTIONAL
BODY	CARBON STEEL, 304 S.S, 316 S.S, ALUMINUM	HASTELLOY [®] , ALLOY 20, MONEL, INCONEL
FLAME ELEMENT	304 S.S, 316 S.S	HASTELLOY [®] , ALLOY 20, MONEL, INCONEL
ELEMENT HOUSING	304 S.S, 316 S.S	HASTELLOY [®] , ALLOY 20, MONEL, INCONEL
STUD BOLT AND NUT	C.S, 304 S.S	316 S.S
PALLET	304 S.S, 316 S.S	HASTELLOY [®] , ALLOY 20
SEAT	304 S.S, 316 S.S, ALUMINUM	HASTELLOY [®] , ALLOY 20
SEATING DIAPHRAGM	FEP TEFLON [®] (Weight loaded type) VITON [®] O-ring (Spring loaded type)	METAL TO METAL
HOOD(MODEL SBF)	304 S.S, ALUMINUM	316 S.S

► Other Special materials such as Hastelloy[®] B/C are available upon customer's request.

MODEL SBG+SFG, SBD+SFG

Sewon Pressure Relief Valve with Flame Arrester

NOMINAL SIZE

- 2", 3", 4", 6", 8", 10", and 12"

CONNECTIONS

- ANSI/ASME B16.5 Class 150 Flange
- KS/JIS 10K Flange

Combination pressure relief valve and flame arrester
Protect storage tank from overpressure and potential ignition source
Air-cushion pallet reduces the internal vapor leakage

TEFLON[®] seating diaphragms are standard
Crimped ribbon flame elements
Drilling conforming to ANSI/ASME B16.5 for class 150 flanges, or KS/JIS 10K flanges. other standards are available on customer's request

► Consult our factory for special application or special design.



Model SBG+SFG

SPECIFICATIONS

Installation	Vertical
Model SBG+SFG	End-of-line, vented to the atmosphere directly
Model SBD+SFG	In-line, a flanged side connection is provided For pipe away of vapors
Flame arrester classification	Deflagration flame arrester, Bi-directional
Set pressure	20mmH ₂ O to 700 mmH ₂ O(Standard specification)
Explosion gas group	IIA(standard), IIB/IIC(for special application)

► Other specifications are available. consult our factory

MATERIALS

PART NAME	MATERIALS	
	STANDARD	OPTIONAL
BODY	CARBON STEEL, 304 S.S, 316 S.S, ALUMINUM	HASTELLOY [®] , ALLOY 20, MONEL, INCONEL
FLAME ELEMENT	304 S.S, 316 S.S	HASTELLOY [®] , ALLOY 20, MONEL, INCONEL
ELEMENT HOUSING	304 S.S, 316 S.S	HASTELLOY [®] , ALLOY 20, MONEL, INCONEL
STUD BOLT AND NUT	C.S, 304 S.S	316 S.S
PALLET	304 S.S, 316 S.S	HASTELLOY [®] , ALLOY 20
SEAT	304 S.S, 316 S.S, ALUMINUM	HASTELLOY [®] , ALLOY 20
SEATING DIAPHRAGM	FEP TEFLON [®] (Weight loaded type) VITON [®] O-ring (Spring loaded type)	METAL TO METAL, VITON
HOOD(MODEL SBG)	304 S.S, ALUMINUM	316 S.S

► Other Special materials such as Hastelloy[®] B/C are available upon customer's request.

Teflon[®] is registered trademark of the Dupont Company.
Viton[®] is registered trademark of DuPont Dow Elastomers.
Hastelloy[®] is the registered trademark of Haynes International, Inc.

END-OF-LINE PRESSURE RELIEF VALVE WITH FLAME ARRESTER

Set Pressure		Air Flow Rates at 100% overpressure (Double of Set Pressure) in 1,000 Nm ³ /h						
mmH ₂ O	mbar	2"	3"	4"	6"	8"	10"	12"
22	2.2	0.10	0.19	0.35	0.62	1.01	1.59	1.82
25	2.5	0.10	0.20	0.37	0.68	1.10	1.73	2.00
50	4.9	0.15	0.31	0.58	1.08	1.74	2.72	3.32
75	7.4	0.18	0.40	0.75	1.41	2.27	3.53	4.38
100	9.8	0.22	0.48	0.90	1.69	2.71	4.23	5.26
125	12	0.25	0.55	1.02	1.93	3.10	4.83	6.03
150	15	0.28	0.61	1.14	2.14	3.44	5.37	6.71
175	17	0.30	0.67	1.24	2.34	3.76	5.86	7.33
200	20	0.32	0.72	1.34	2.52	4.05	6.31	7.92
225	22	0.34	0.77	1.43	2.70	4.33	6.74	8.47
250	25	0.37	0.81	1.52	2.86	4.59	7.15	8.99
275	27	0.38	0.86	1.60	3.02	4.84	7.54	9.50
300	29	0.40	0.90	1.68	3.17	5.08	7.92	9.98
325	32	0.42	0.94	1.76	3.32	5.32	8.28	10.45
350	34	0.44	0.98	1.83	3.46	5.55	8.64	10.91
375	37	0.46	1.02	1.90	3.60	5.77	8.98	11.35
400	39	0.47	1.06	1.97	3.74	5.98	9.31	11.78
450	44	0.50	1.13	2.11	4.00	6.40	9.95	12.60
500	49	0.53	1.20	2.24	4.24	6.79	10.56	13.37
550	54	0.56	1.26	2.36	4.48	7.17	11.14	14.11
600	59	0.59	1.33	2.48	4.70	7.52	11.69	14.80
700	69	0.64	1.44	2.70	5.12	8.19	12.72	16.08

Notes

- Flow rates listed in above Table are based on full open valves at 100% overpressure.
- If the set pressure is not listed above Table, use liner interpolation.
- If the overpressure is less than 100%, calculate the flow rates using the Factor "C"

Example of Flow Rate Calculation

Model SBF+SFG 10"

Set pressure(P_{set})=150mmH₂O(15mbar)

Inlet pressure(P_{in})=250mmH₂O

- Calculate overpressure

$$\text{Overpressure} = \frac{P_{in} - P_{set}}{P_{set}} \times 100 = 67(\%)$$

- Determine Factor C from right Table C=0.82

- Read flow rate at 100%

overpressure corresponding specified

set pressure. The flow rate is 5,370Nm³/h from above Table.

- Calculate flow rate at specified inlet pressure Flow rate at 250mmH₂O=0.82×5,370=4,403Nm³/h

* The flow rates are based on the Sewon Standard Model. For special application to achieve better flow rate performance, please consult to factory.

Factor C for less than 100% over-pressure										
%	0	1	2	3	4	5	6	7	8	9
10	0.40	0.42	0.43	0.45	0.46	0.47	0.48	0.49	0.50	0.51
20	0.52	0.53	0.53	0.54	0.55	0.56	0.56	0.57	0.58	0.58
30	0.59	0.60	0.60	0.61	0.62	0.62	0.63	0.64	0.64	0.65
40	0.66	0.66	0.67	0.67	0.68	0.69	0.69	0.70	0.70	0.71
50	0.72	0.72	0.73	0.73	0.74	0.75	0.75	0.76	0.76	0.77
60	0.78	0.78	0.79	0.79	0.80	0.80	0.81	0.82	0.82	0.83
70	0.83	0.84	0.84	0.85	0.86	0.86	0.87	0.87	0.88	0.88
80	0.89	0.89	0.90	0.90	0.91	0.91	0.92	0.93	0.93	0.94
90	0.94	0.95	0.95	0.96	0.96	0.97	0.97	0.98	0.98	0.99

NOTES) THE VALUES LISTED ABOVE RANGE FROM 10% TO 40% ARE FOR REFERENCE

END-OF-LINE VACUUM RELIEF VALVE WITH FLAME ARRESTER

Set Vacuum		Air Flow Rates at 100% overpressure (Double of Set Vacuum) in 1,000 Nm ³ /h						
mmH ₂ O	mbar	2"	3"	4"	6"	8"	10"	12"
-22	-2.2	0.075	0.156	0.279	0.504	0.818	1.240	1.531
-25	-2.5	0.080	0.169	0.299	0.544	0.879	1.334	1.660
-50	-4.9	0.119	0.260	0.446	0.835	1.330	2.028	2.611
-75	-7.4	0.150	0.333	0.568	1.073	1.705	2.597	3.397
-100	-9.8	0.177	0.395	0.673	1.275	2.027	3.080	4.065
-125	-12	0.200	0.449	0.765	1.450	2.308	3.504	4.646
-150	-15	0.221	0.497	0.848	1.608	2.560	3.883	5.166
-175	-17	0.240	0.541	0.924	1.751	2.792	4.232	5.640
-200	-20	0.258	0.582	0.995	1.886	3.007	4.557	6.078
-225	-22	0.275	0.621	1.062	2.013	3.209	4.864	6.490
-250	-25	0.291	0.658	1.126	2.135	3.402	5.157	6.882
-275	-27	0.306	0.694	1.187	2.251	3.587	5.438	7.256
-300	-29	0.321	0.728	1.246	2.364	3.764	5.709	7.617
-325	-32	0.336	0.762	1.303	2.472	3.936	5.971	7.967
-350	-34	0.350	0.794	1.359	2.577	4.103	6.224	8.307
-375	-37	0.364	0.826	1.413	2.680	4.265	6.471	8.637
-400	-39	0.377	0.856	1.465	2.779	4.423	6.710	8.960
-450	-44	0.403	0.915	1.566	2.972	4.726	7.170	9.582
-500	-49	0.429	0.972	1.662	3.153	5.016	7.606	10.178
-550	-54	0.453	1.025	1.753	3.326	5.291	8.017	10.748
-600	-59	0.476	1.077	1.840	3.491	5.553	8.409	11.294
-700	-69	0.520	1.172	2.001	3.796	6.044	9.133	12.323

Notes

- Flow rates listed in above Table are based on full open valves at 100% overpressure.
- If the set Vacuum is not listed above Table, use liner interpolation.
- If the negative overpressure is less than 100%, calculate the flow rates using the Factor "C"

Example of Flow Rate Calculation

Model SBF+SFG 8"

Set Vacuum(P_{set})=-200mmH₂O(-20mbar)

Inlet pressure(P_{in})=-330mmH₂O

- Calculate overpressure

$$\text{Overpressure} = \frac{P_{in} - P_{set}}{P_{set}} \times 100 = 65(\%)$$

- Determine Factor C from right Table C=0.80

- Read flow rate at 100%

negative overpressure corresponding

specified set pressure. The flow rate is 3,007Nm³/h from above Table.

- Calculate flow rate at specified inlet pressure Flow rate at -330mmH₂O=0.80 × 3,007=2,406Nm³/h

* The flow rates are based on the Sewon Standard Model. For special application to achieve better flow rate performance, please consult to factory.

Factor C for less than 100% negative over-pressure										
%	0	1	2	3	4	5	6	7	8	9
10	0.40	0.42	0.43	0.45	0.46	0.47	0.48	0.49	0.50	0.51
20	0.52	0.53	0.53	0.54	0.55	0.56	0.56	0.57	0.58	0.58
30	0.59	0.60	0.60	0.61	0.62	0.62	0.63	0.64	0.64	0.65
40	0.66	0.66	0.67	0.67	0.68	0.69	0.69	0.70	0.70	0.71
50	0.72	0.72	0.73	0.73	0.74	0.75	0.75	0.76	0.76	0.77
60	0.78	0.78	0.79	0.79	0.80	0.80	0.81	0.82	0.82	0.83
70	0.83	0.84	0.84	0.85	0.86	0.86	0.87	0.87	0.88	0.88
80	0.89	0.89	0.90	0.90	0.91	0.91	0.92	0.93	0.93	0.94
90	0.94	0.95	0.95	0.96	0.96	0.97	0.97	0.98	0.98	0.99

NOTES) THE VALUES LISTED ABOVE RANGE FROM 10% TO 40% ARE FOR REFERENCE.

IN-LINE PRESSURE RELIEF VALVE WITH FLAME ARRESTER

Set Pressure		Air Flow Rates at 100% overpressure (Double of Set Pressure) in 1,000 Nm ³ /h						
mmH ₂ O	mbar	2"	3"	4"	6"	8"	10"	12"
22	2.2	0.085	0.178	0.333	0.592	0.926	1.475	1.703
25	2.5	0.092	0.193	0.359	0.641	1.002	1.595	1.865
50	4.9	0.140	0.299	0.555	1.004	1.564	2.487	3.051
75	7.4	0.179	0.385	0.717	1.304	2.026	3.220	4.011
100	9.8	0.212	0.457	0.855	1.559	2.417	3.842	4.815
125	12	0.241	0.520	0.975	1.782	2.758	4.385	5.513
150	15	0.267	0.577	1.083	1.981	3.064	4.871	6.135
175	17	0.291	0.629	1.183	2.163	3.343	5.315	6.702
200	20	0.314	0.677	1.275	2.332	3.603	5.728	7.231
225	22	0.335	0.723	1.362	2.492	3.846	6.118	7.730
250	25	0.355	0.767	1.445	2.643	4.079	6.489	8.204
275	27	0.374	0.810	1.525	2.788	4.301	6.843	8.660
300	29	0.393	0.850	1.602	2.928	4.517	7.184	9.099
325	32	0.410	0.890	1.676	3.063	4.724	7.514	9.524
350	34	0.428	0.928	1.748	3.194	4.925	7.834	9.937
375	37	0.445	0.965	1.818	3.321	5.121	8.145	10.339
400	39	0.461	1.001	1.885	3.445	5.312	8.447	10.730
450	44	0.493	1.070	2.016	3.683	5.678	9.026	11.483
500	49	0.523	1.136	2.140	3.910	6.028	9.576	12.199
550	54	0.552	1.197	2.257	4.126	6.361	10.099	12.880
600	59	0.580	1.255	2.369	4.332	6.677	10.597	13.528
700	69	0.631	1.362	2.576	4.715	7.268	11.518	14.734

Notes

- Flow rates listed in above Table are based on full open valves at 100% overpressure.
- If the set pressure is not listed above Table, use liner interpolation.
- If the overpressure is less than 100%, calculate the flow rates using the Factor "C"

Example of Flow Rate Calculation

Model SBB+SFG 4"

Set pressure(P_{set})=150mmH₂O(15mbar)

Inlet pressure(P_{in})=230mmH₂O

- Calculate overpressure

$$\text{Overpressure} = \frac{P_{in} - P_{set}}{P_{set}} \times 100 = 53(\%)$$

- Determine Factor C from right Table C=0.73

- Read flow rate at 100%

overpressure corresponding specified

set pressure. The flow rate is 1,083Nm³/h from above Table.

- Calculate flow rate at specified inlet pressure Flow rate at 230mmH₂O=0.73 × 1,083=791Nm³/h

* The flow rates are based on the Sewon Standard Model. For special application to achieve better flow rate performance, please consult to factory.

Factor C for less than 100% over-pressure										
%	0	1	2	3	4	5	6	7	8	9
10	0.40	0.42	0.43	0.45	0.46	0.47	0.48	0.49	0.50	0.51
20	0.52	0.53	0.53	0.54	0.55	0.56	0.56	0.57	0.58	0.58
30	0.59	0.60	0.60	0.61	0.62	0.62	0.63	0.64	0.64	0.65
40	0.66	0.66	0.67	0.67	0.68	0.69	0.69	0.70	0.70	0.71
50	0.72	0.72	0.73	0.73	0.74	0.75	0.75	0.76	0.76	0.77
60	0.78	0.78	0.79	0.79	0.80	0.80	0.81	0.82	0.82	0.83
70	0.83	0.84	0.84	0.85	0.86	0.86	0.87	0.87	0.88	0.88
80	0.89	0.89	0.90	0.90	0.91	0.91	0.92	0.93	0.93	0.94
90	0.94	0.95	0.95	0.96	0.96	0.97	0.97	0.98	0.98	0.99

NOTES) THE VALUES LISTED ABOVE RANGE FROM 10% TO 40% ARE FOR REFERENCE

IN-LINE VACUUM RELIEF VALVE FLAME ARRESTER

Set Vacuum		Air Flow Rates at 100% overpressure (Double of Set Vacuum) in 1,000 Nm ³ /h						
mmH ₂ O	mbar	2"	3"	4"	6"	8"	10"	12"
-22	-2.2	0.075	0.156	0.279	0.504	0.818	1.240	1.531
-25	-2.5	0.080	0.169	0.299	0.544	0.879	1.334	1.660
-50	-4.9	0.119	0.260	0.446	0.835	1.330	2.028	2.611
-75	-7.4	0.150	0.333	0.568	1.073	1.705	2.597	3.397
-100	-9.8	0.177	0.395	0.673	1.275	2.027	3.080	4.065
-125	-12	0.200	0.449	0.765	1.450	2.308	3.504	4.646
-150	-15	0.221	0.497	0.848	1.608	2.560	3.883	5.166
-175	-17	0.240	0.541	0.924	1.751	2.792	4.232	5.640
-200	-20	0.258	0.582	0.995	1.886	3.007	4.557	6.078
-225	-22	0.275	0.621	1.062	2.013	3.209	4.864	6.490
-250	-25	0.291	0.658	1.126	2.135	3.402	5.157	6.882
-275	-27	0.306	0.694	1.187	2.251	3.587	5.438	7.256
-300	-29	0.321	0.728	1.246	2.364	3.764	5.709	7.617
-325	-32	0.336	0.762	1.303	2.472	3.936	5.971	7.967
-350	-34	0.350	0.794	1.359	2.577	4.103	6.224	8.307
-375	-37	0.364	0.826	1.413	2.680	4.265	6.471	8.637
-400	-39	0.377	0.856	1.465	2.779	4.423	6.710	8.960
-450	-44	0.403	0.915	1.566	2.972	4.726	7.170	9.582
-500	-49	0.429	0.972	1.662	3.153	5.016	7.606	10.178
-550	-54	0.453	1.025	1.753	3.326	5.291	8.017	10.748
-600	-59	0.476	1.077	1.840	3.491	5.553	8.409	11.294
-700	-69	0.520	1.172	2.001	3.796	6.044	9.133	12.323

Notes

- Flow rates listed in above Table are based on full open valves at 100% overpressure.
- If the set Vacuum is not listed above Table, use liner interpolation.
- If the negative overpressure is less than 100%, calculate the flow rates using the Factor "C"

Example of Flow Rate Calculation

Model SBB+SFG 8"

Set Vacuum(P_{set})=-25mmH₂O(-2.5mbar)

Inlet pressure(P_{in})=-40mmH₂O

- Calculate overpressure

$$\text{Overpressure} = \frac{P_{in} - P_{set}}{P_{set}} \times 100 = 60(\%)$$

- Determine Factor C from right Table C=0.78

- Read flow rate at 100%

negative overpressure corresponding

specified set pressure. The flow rate is 879Nm³/h from above Table.

- Calculate flow rate at specified inlet pressure Flow rate at -40mmH₂O=0.78×879=686Nm³/h

* The flow rates are based on the Sewon Standard Model. For special application to achieve better flow rate performance, please consult to factory.

Factor C for less than 100% negative over-pressure										
%	0	1	2	3	4	5	6	7	8	9
10	0.40	0.42	0.43	0.45	0.46	0.47	0.48	0.49	0.50	0.51
20	0.52	0.53	0.53	0.54	0.55	0.56	0.56	0.57	0.58	0.58
30	0.59	0.60	0.60	0.61	0.62	0.62	0.63	0.64	0.64	0.65
40	0.66	0.66	0.67	0.67	0.68	0.69	0.69	0.70	0.70	0.71
50	0.72	0.72	0.73	0.73	0.74	0.75	0.75	0.76	0.76	0.77
60	0.78	0.78	0.79	0.79	0.80	0.80	0.81	0.82	0.82	0.83
70	0.83	0.84	0.84	0.85	0.86	0.86	0.87	0.87	0.88	0.88
80	0.89	0.89	0.90	0.90	0.91	0.91	0.92	0.93	0.93	0.94
90	0.94	0.95	0.95	0.96	0.96	0.97	0.97	0.98	0.98	0.99

NOTES) THE VALUES LISTED ABOVE RANGE FROM 10% TO 40% ARE FOR REFERENCE.

END-OF-LINE PRESSURE RELIEF VALVE WITH FLAME ARRESTER

Set Pressure		Air Flow Rates at 100% overpressure (Double of Set Pressure) in 1,000 Nm ³ /h						
mmH ₂ O	mbar	2"	3"	4"	6"	8"	10"	12"
22	2.2	0.081	0.179	0.344	0.617	0.962	1.512	1.914
25	2.5	0.086	0.193	0.371	0.671	1.045	1.640	2.104
50	4.9	0.124	0.295	0.573	1.070	1.656	2.582	3.488
75	7.4	0.157	0.381	0.741	1.395	2.155	3.357	4.598
100	9.8	0.185	0.455	0.886	1.670	2.576	4.014	5.524
125	12	0.211	0.520	1.012	1.908	2.943	4.586	6.327
150	15	0.234	0.579	1.126	2.122	3.271	5.098	7.044
175	17	0.255	0.632	1.229	2.317	3.570	5.565	7.700
200	20	0.274	0.682	1.325	2.499	3.848	5.999	8.312
225	22	0.292	0.728	1.416	2.670	4.110	6.407	8.890
250	25	0.310	0.772	1.501	2.833	4.360	6.795	9.441
275	27	0.326	0.814	1.583	2.989	4.599	7.167	9.971
300	29	0.342	0.855	1.662	3.141	4.830	7.524	10.481
325	32	0.358	0.894	1.738	3.287	5.054	7.870	10.973
350	34	0.373	0.931	1.811	3.428	5.270	8.205	11.451
375	37	0.387	0.968	1.883	3.566	5.480	8.530	11.915
400	39	0.401	1.003	1.952	3.699	5.685	8.846	12.364
450	44	0.428	1.072	2.086	3.956	6.078	9.456	13.226
500	49	0.454	1.137	2.214	4.201	6.452	10.034	14.041
550	54	0.478	1.199	2.335	4.433	6.808	10.584	14.811
600	59	0.502	1.258	2.452	4.654	7.147	11.108	15.541
700	69	0.545	1.369	2.669	5.064	7.777	12.083	16.883

Notes

- Flow rates listed in above Table are based on full open valves at 100% overpressure.
- If the set pressure is not listed above Table, use liner interpolation.
- If the overpressure is less than 100%, calculate the flow rates using the Factor "C"

Example of Flow Rate Calculation

Model SBF+SFH 10"

Set pressure(P_{set})=150mmH₂O(15mbar)

Inlet pressure(P_{in})=250mmH₂O

- Calculate overpressure

$$\text{Overpressure} = \frac{P_{in} - P_{set}}{P_{set}} \times 100 = 67(\%)$$

- Determine Factor C from right Table C=0.82

- Read flow rate at 100%

overpressure corresponding specified

set pressure. The flow rate is 5,098Nm³/h from above Table.

- Calculate flow rate at specified inlet pressure Flow rate at 250mmH₂O=0.82 × 5,098=4,180Nm³/h

* The flow rates are based on the Sewon Standard Model. For special application to achieve better flow rate performance, please consult to factory.

Factor C for less than 100% over-pressure										
%	0	1	2	3	4	5	6	7	8	9
10	0.40	0.42	0.43	0.45	0.46	0.47	0.48	0.49	0.50	0.51
20	0.52	0.53	0.53	0.54	0.55	0.56	0.56	0.57	0.58	0.58
30	0.59	0.60	0.60	0.61	0.62	0.62	0.63	0.64	0.64	0.65
40	0.66	0.66	0.67	0.67	0.68	0.69	0.69	0.70	0.70	0.71
50	0.72	0.72	0.73	0.73	0.74	0.75	0.75	0.76	0.76	0.77
60	0.78	0.78	0.79	0.79	0.80	0.80	0.81	0.82	0.82	0.83
70	0.83	0.84	0.84	0.85	0.86	0.86	0.87	0.87	0.88	0.88
80	0.89	0.89	0.90	0.90	0.91	0.91	0.92	0.93	0.93	0.94
90	0.94	0.95	0.95	0.96	0.96	0.97	0.97	0.98	0.98	0.99

(NOTES) THE VALUES LISTED ABOVE RANGE FROM 10% TO 40% ARE FOR REFERENCE

END-OF-LINE VACUUM RELIEF VALVE WITH FLAME ARRESTER

Set Vacuum		Air Flow Rates at 100% overpressure (Double of Set Vacuum) in 1,000 Nm ³ /h						
mmH ₂ O	mbar	2"	3"	4"	6"	8"	10"	12"
-22	-2.2	0.064	0.148	0.276	0.500	0.777	1.177	1.608
-25	-2.5	0.068	0.160	0.296	0.539	0.835	1.267	1.742
-50	-4.9	0.101	0.246	0.442	0.827	1.264	1.926	2.742
-75	-7.4	0.127	0.317	0.563	1.063	1.620	2.468	3.567
-100	-9.8	0.150	0.375	0.666	1.262	1.926	2.927	4.269
-125	-12	0.170	0.427	0.757	1.435	2.192	3.328	4.879
-150	-15	0.188	0.472	0.839	1.592	2.432	3.690	5.424
-175	-17	0.204	0.514	0.914	1.735	2.652	4.021	5.921
-200	-20	0.220	0.553	0.985	1.867	2.856	4.330	6.382
-225	-22	0.234	0.590	1.051	1.993	3.048	4.622	6.815
-250	-25	0.247	0.625	1.114	2.113	3.232	4.899	7.226
-275	-27	0.261	0.659	1.175	2.228	3.407	5.167	7.619
-300	-29	0.273	0.692	1.234	2.339	3.576	5.424	7.999
-325	-32	0.285	0.724	1.290	2.447	3.739	5.672	8.366
-350	-34	0.297	0.754	1.345	2.552	3.898	5.913	8.722
-375	-37	0.309	0.784	1.398	2.652	4.052	6.147	9.069
-400	-39	0.320	0.814	1.450	2.751	4.202	6.375	9.407
-450	-44	0.342	0.870	1.550	2.941	4.490	6.812	10.061
-500	-49	0.364	0.923	1.645	3.122	4.765	7.225	10.687
-550	-54	0.384	0.974	1.735	3.293	5.026	7.617	11.285
-600	-59	0.404	1.023	1.821	3.456	5.276	7.989	11.860
-700	-69	0.442	1.113	1.981	3.758	5.741	8.677	12.940

Notes

- Flow rates listed in above Table are based on full open valves at 100% overpressure.
- If the set Vacuum is not listed above Table, use liner interpolation.
- If the negative overpressure is less than 100%, calculate the flow rates using the Factor "C"

Example of Flow Rate Calculation

Model SBF+SFH 8"

Set Vacuum(P_{set})=-200mmH₂O(-20mbar)

Inlet pressure(P_{in})=-330mmH₂O

- Calculate overpressure

$$\text{Overpressure} = \frac{P_{in} - P_{set}}{P_{set}} \times 100 = 65(\%)$$

- Determine Factor C from right Table C=0.80

- Read flow rate at 100%

negative overpressure corresponding

specified set pressure. The flow rate is 2,856Nm³/h from above Table.

- Calculate flow rate at specified inlet pressure Flow rate at -330mmH₂O=0.80 × 2,856=2,285Nm³/h

* The flow rates are based on the Sewon Standard Model. For special application to achieve better flow rate performance, please consult to factory.

Factor C for less than 100% negative over-pressure										
%	0	1	2	3	4	5	6	7	8	9
10	0.40	0.42	0.43	0.45	0.46	0.47	0.48	0.49	0.50	0.51
20	0.52	0.53	0.53	0.54	0.55	0.56	0.56	0.57	0.58	0.58
30	0.59	0.60	0.60	0.61	0.62	0.62	0.63	0.64	0.64	0.65
40	0.66	0.66	0.67	0.67	0.68	0.69	0.69	0.70	0.70	0.71
50	0.72	0.72	0.73	0.73	0.74	0.75	0.75	0.76	0.76	0.77
60	0.78	0.78	0.79	0.79	0.80	0.80	0.81	0.82	0.82	0.83
70	0.83	0.84	0.84	0.85	0.86	0.86	0.87	0.87	0.88	0.88
80	0.89	0.89	0.90	0.90	0.91	0.91	0.92	0.93	0.93	0.94
90	0.94	0.95	0.95	0.96	0.96	0.97	0.97	0.98	0.98	0.99

NOTES) THE VALUES LISTED ABOVE RANGE FROM 10% TO 40% ARE FOR REFERENCE.

IN-LINE PRESSURE RELIEF VALVE WITH FLAME ARRESTER

Set Pressure		Air Flow Rates at 100% overpressure (Double of Set Pressure) in 1,000 Nm ³ /h						
mmH ₂ O	mbar	2"	3"	4"	6"	8"	10"	12"
22	2.2	0.073	0.169	0.329	0.587	0.880	1.400	1.789
25	2.5	0.078	0.183	0.355	0.636	0.952	1.515	1.959
50	4.9	0.119	0.285	0.550	0.995	1.486	2.363	3.204
75	7.4	0.152	0.366	0.710	1.292	1.924	3.060	4.212
100	9.8	0.180	0.434	0.846	1.543	2.296	3.650	5.056
125	12	0.205	0.494	0.965	1.763	2.621	4.166	5.788
150	15	0.228	0.548	1.072	1.961	2.911	4.627	6.441
175	17	0.248	0.597	1.171	2.141	3.176	5.049	7.038
200	20	0.267	0.643	1.262	2.309	3.422	5.442	7.592
225	22	0.285	0.687	1.349	2.467	3.655	5.812	8.115
250	25	0.302	0.729	1.431	2.616	3.875	6.163	8.614
275	27	0.318	0.769	1.510	2.760	4.086	6.500	9.092
300	29	0.334	0.808	1.586	2.898	4.290	6.824	9.555
325	32	0.349	0.845	1.659	3.032	4.488	7.139	10.001
350	34	0.364	0.882	1.730	3.162	4.679	7.442	10.435
375	37	0.378	0.917	1.800	3.288	4.865	7.738	10.856
400	39	0.392	0.951	1.867	3.410	5.046	8.025	11.268
450	44	0.419	1.017	1.996	3.646	5.394	8.575	12.057
500	49	0.445	1.079	2.119	3.871	5.726	9.098	12.809
550	54	0.469	1.137	2.235	4.085	6.042	9.594	13.524
600	59	0.493	1.193	2.346	4.289	6.343	10.066	14.205
700	69	0.536	1.294	2.550	4.668	6.905	10.942	15.470

Notes

- Flow rates listed in above Table are based on full open valves at 100% overpressure.
- If the set pressure is not listed above Table, use liner interpolation.
- If the overpressure is less than 100%, calculate the flow rates using the Factor "C"

Example of Flow Rate Calculation

Model SBB+SFH 4"

Set pressure(P_{set})=150mmH₂O(15mbar)

Inlet pressure(P_{in})=230mmH₂O

- Calculate overpressure

$$\text{Overpressure} = \frac{P_{in} - P_{set}}{P_{set}} \times 100 = 53(\%)$$

- Determine Factor C from right Table C=0.73

- Read flow rate at 100%

overpressure corresponding specified

set pressure. The flow rate is 1,072Nm³/h from above Table.

- Calculate flow rate at specified inlet pressure Flow rate at 230mmH₂O=0.73 × 1,072=783Nm³/h

* The flow rates are based on the Sewon Standard Model. For special application to achieve better flow rate performance, please consult to factory.

Factor C for less than 100% over-pressure										
%	0	1	2	3	4	5	6	7	8	9
10	0.40	0.42	0.43	0.45	0.46	0.47	0.48	0.49	0.50	0.51
20	0.52	0.53	0.53	0.54	0.55	0.56	0.56	0.57	0.58	0.58
30	0.59	0.60	0.60	0.61	0.62	0.62	0.63	0.64	0.64	0.65
40	0.66	0.66	0.67	0.67	0.68	0.69	0.69	0.70	0.70	0.71
50	0.72	0.72	0.73	0.73	0.74	0.75	0.75	0.76	0.76	0.77
60	0.78	0.78	0.79	0.79	0.80	0.80	0.81	0.82	0.82	0.83
70	0.83	0.84	0.84	0.85	0.86	0.86	0.87	0.87	0.88	0.88
80	0.89	0.89	0.90	0.90	0.91	0.91	0.92	0.93	0.93	0.94
90	0.94	0.95	0.95	0.96	0.96	0.97	0.97	0.98	0.98	0.99

NOTES) THE VALUES LISTED ABOVE RANGE FROM 10% TO 40% ARE FOR REFERENCE

IN-LINE VACUUM RELIEF VALVE WITH FLAME ARRESTER

Set Vacuum		Air Flow Rates at 100% overpressure (Double of Set Vacuum) in 1,000 Nm ³ /h						
mmH ₂ O	mbar	2"	3"	4"	6"	8"	10"	12"
-22	-2.2	0.064	0.148	0.276	0.500	0.777	1.177	1.608
-25	-2.5	0.068	0.160	0.296	0.539	0.835	1.267	1.742
-50	-4.9	0.101	0.246	0.442	0.827	1.264	1.926	2.742
-75	-7.4	0.127	0.317	0.563	1.063	1.620	2.468	3.567
-100	-9.8	0.150	0.375	0.666	1.262	1.926	2.927	4.269
-125	-12	0.170	0.427	0.757	1.435	2.192	3.328	4.879
-150	-15	0.188	0.472	0.839	1.592	2.432	3.690	5.424
-175	-17	0.204	0.514	0.914	1.735	2.652	4.021	5.921
-200	-20	0.220	0.553	0.985	1.867	2.856	4.330	6.382
-225	-22	0.234	0.590	1.051	1.993	3.048	4.622	6.815
-250	-25	0.247	0.625	1.114	2.113	3.232	4.899	7.226
-275	-27	0.261	0.659	1.175	2.228	3.407	5.167	7.619
-300	-29	0.273	0.692	1.234	2.339	3.576	5.424	7.999
-325	-32	0.285	0.724	1.290	2.447	3.739	5.672	8.366
-350	-34	0.297	0.754	1.345	2.552	3.898	5.913	8.722
-375	-37	0.309	0.784	1.398	2.652	4.052	6.147	9.069
-400	-39	0.320	0.814	1.450	2.751	4.202	6.375	9.407
-450	-44	0.342	0.870	1.550	2.941	4.490	6.812	10.061
-500	-49	0.364	0.923	1.645	3.122	4.765	7.225	10.687
-550	-54	0.384	0.974	1.735	3.293	5.026	7.617	11.285
-600	-59	0.404	1.023	1.821	3.456	5.276	7.989	11.860
-700	-69	0.442	1.113	1.981	3.758	5.741	8.677	12.940

Notes

- Flow rates listed in above Table are based on full open valves at 100% overpressure.
- If the set Vacuum is not listed above Table, use liner interpolation.
- If the negative overpressure is less than 100%, calculate the flow rates using the Factor "C"

Example of Flow Rate Calculation

Model SBB+SFH 8"

Set Vacuum(P_{set})=-25mmH₂O(-2.5mbar)

Inlet pressure(P_{in})=-40mmH₂O

- Calculate overpressure

$$\text{Overpressure} = \frac{P_{in} - P_{set}}{P_{set}} \times 100 = 60(\%)$$

- Determine Factor C from right Table C=0.78

- Read flow rate at 100%

negative overpressure corresponding

specified set pressure. The flow rate is 835Nm³/h from above Table.

- Calculate flow rate at specified inlet pressure Flow rate at -40mmH₂O=0.78 × 835=651Nm³/h

* The flow rates are based on the Sewon Standard Model. For special application to achieve better flow rate performance, please consult to factory.

Factor C for less than 100% negative over-pressure										
%	0	1	2	3	4	5	6	7	8	9
10	0.40	0.42	0.43	0.45	0.46	0.47	0.48	0.49	0.50	0.51
20	0.52	0.53	0.53	0.54	0.55	0.56	0.56	0.57	0.58	0.58
30	0.59	0.60	0.60	0.61	0.62	0.62	0.63	0.64	0.64	0.65
40	0.66	0.66	0.67	0.67	0.68	0.69	0.69	0.70	0.70	0.71
50	0.72	0.72	0.73	0.73	0.74	0.75	0.75	0.76	0.76	0.77
60	0.78	0.78	0.79	0.79	0.80	0.80	0.81	0.82	0.82	0.83
70	0.83	0.84	0.84	0.85	0.86	0.86	0.87	0.87	0.88	0.88
80	0.89	0.89	0.90	0.90	0.91	0.91	0.92	0.93	0.93	0.94
90	0.94	0.95	0.95	0.96	0.96	0.97	0.97	0.98	0.98	0.99

NOTES) THE VALUES LISTED ABOVE RANGE FROM 10% TO 40% ARE FOR REFERENCE.

VALVE CAPACITY & SIZING

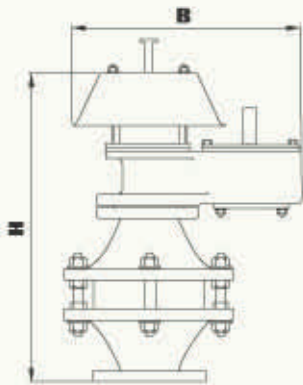

MODEL SBF+SFG

Size (inch)	H (mm)	B (mm)	Approx. Weight [Kg] (At Min. Setting)	
			C.S	Aluminum
2"	495	320	23.5	13
3"	545	400	44	19
4"	580	450	68	28
6"	680	590	118	53
8"	740	690	170	85
10"	765	800	239	145
12"	845	930	335	213

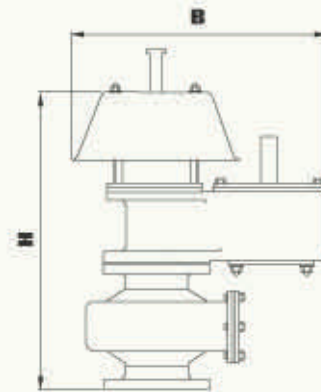

MODEL SBF+SFH

Size (inch)	H (mm)	B (mm)	Approx. Weight [Kg] (At Min. Setting)	
			C.S	Aluminum
2"	410	320	24.5	14
3"	450	400	35.5	22.5
4"	500	450	68	26
6"	590	590	116	45
8"	725	690	152	58
10"	750	800	196	83
12"	840	930	308	128

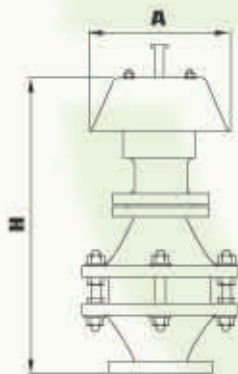

MODEL SBG+SFG

Size (inch)	H (mm)	A (mm)	Approx. Weight [Kg] (At Min. Setting)	
			C.S	Aluminum
2"	495	200	26	13
3"	545	270	40	18
4"	580	280	58.5	27
6"	680	345	108	50
8"	740	400	155	81
10"	765	400	230	137
12"	845	500	317	201

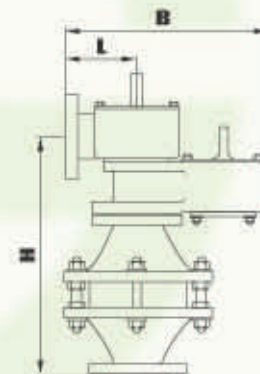

MODEL SBB+SFG

Size (inch)	H (mm)	L (mm)	B (mm)	Approx. Weight [Kg] (At Min. Setting)	
				C.S	Aluminum
2"	435	115	340	32	16
3"	485	145	415	59	24
4"	500	180	495	82	35
6"	610	215	605	150	63
8"	675	300	775	225	104
10"	725	300	860	309	173
12"	810	360	1030	455	249

Actual dimensions may vary from these listed dimensions due to variations or revisions of specifications. The dimensions may change without notice. For more information, consult our factory.

DIMENSIONS

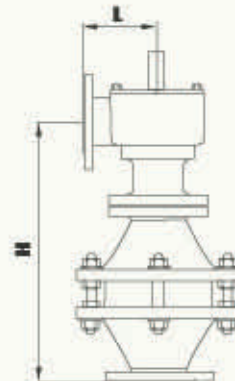
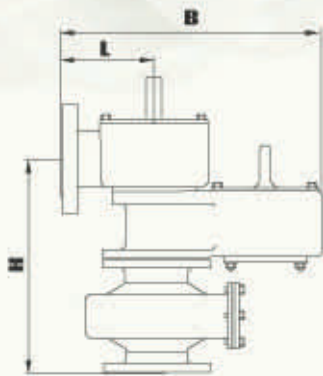

MODEL SBB+SFH





Size (inch)	H (mm)	L (mm)	B (mm)	Approx. Weight [Kg] (At Min. Setting)	
				C.S	Aluminum
2"	350	115	340	33	17
3"	390	145	415	67	28
4"	420	180	495	82	33
6"	520	215	605	148	55
8"	660	300	775	207	77
10"	710	300	860	266	111
12"	805	360	1030	428	164

MODEL SBD+SFG

Size (inch)	H (mm)	L (mm)	Approx. Weight [Kg] (At Min. Setting)	
			C.S	Aluminum
2"	435	115	23	15
3"	485	145	48	21
4"	500	180	69	31
6"	610	215	135	63
8"	675	300	205	103
10"	725	300	257	155
12"	810	360	350	224

Actual dimensions may vary from these listed dimensions due to variations or revisions of specifications. The dimensions may change without notice. For more information, consult our factory.

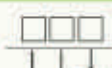
HOW TO ORDER

MODEL	TYPE	INLET SIZE	MATERIALS	FLANGE DRILLING	OPTION
 SBF+SFG SBF+SFH SBG+SFG SBB+SFG SBB+SFH SBD+SFG	 W: Weight loaded for P/V sides S: Spring loaded for pressure side N: Spring loaded for vacuum side D: Spring loaded for P/V sides (Dual spring loaded)	 02 : 2" 03 : 3" 04 : 4" 06 : 6" 08 : 8" 10 : 10" 12 : 12" SS : Special	 Pallet Seat Body C : Carbon Steel 4 : 304 S.S 5 : 304L S.S 6 : 316 S.S 7 : 316L S.S A : Aluminum S : Special Material	 AR : ANSI Class 150 RF AF : ANSI Class 150 FF KR : KS/JIS 10K RF KF : KS/JIS 10K FF NO : NO Drilling SS : Special	 O : No Option J : Steam Jacket S : Special

EXAMPLE

SBF+SFG-W-03-C44-AR-0

Means a 3" model SBF+SFG, weight loaded type for pressure & vacuum sides, with carbon steel body, 304 SS seat, 304 SS pallet, ANSI Class 150 RF flange drilling and no other option.

SEWON EMERGENCY MANHOLE COVER VENT

WEIGHT LOADED EMERGENCY VENT

SPRING LOADED EMERGENCY VENT



SEWON Q&TECH CO.,LTD.

■ HEAD OFFICE/FACTORY

103B-2, CHUNGOK-RI, JUCHON-MYUN, KIMHAE,
KYEONG-NAM, KOREA. 621-840
Tel: +82-55-323-5894~7
Fax: +82-55-323-5898
<http://www.swqt.co.kr>
<http://www.sewon-ind.co.kr>
E-mail: helpdesk@swqt.co.kr

■ SEOUL OFFICE

3FL, 29-13, KARAK-DONG, SONGPA-KU,
SEOUL, KOREA. 138-160
Tel: +82-2-406-5013~4/406-7021
Fax: +82-2-406-7022
E-mail: helpdesk@swqt.co.kr

MODEL SEA EMERGENCY VENT

Sewon SEA Conventional Emergency Vent

NOMINAL SIZE

- 16", 18", 20", and 24"
- Other sizes or specifications are available upon request.

CONNECTIONS

- API 650 Flange drilling
(For 20" & 24" only)
- ANSI/ASME 150Lbs Flange drilling
- KS/JIS 5K Flange drilling
- KS/JIS 10K Flange drilling

Enables emergency relief when fire exposure
Remains closed position when normal operating condition
Can be used as manhole cover for storage tank maintenance
Air-cushion pallet reduces the vapor leakage from storage tank



SPECIFICATIONS

Installation	Vertical
Type	Weight loaded, conventional vent
Set pressure	Maximum 700mmH ₂ O

Use spring loaded emergency vents when the set pressure over 700 mmH₂O
Other specifications are available. consult our factory.

Drilling conforming to API 650, ANSI/ASME B16.5 for class 150 flanges.
or KS/JIS 5K/10K flanges.
Other standards are available on customer's request.
Consult our factory for special application or special design.

MATERIALS

PART NAME	MATERIALS	
	STANDARD	OPTIONAL
BODY	CARBON STEEL, 304 S.S, 316 S.S, ALUMINUM	HASTELLOY [®] , ALLOY 20, FRP, PTFE, ETFE LINED
PALLET	304 S.S, 316 S.S	HASTELLOY [®] , ALLOY 20, FRP, PTFE, ETFE LINED
WEIGHT	A36	304 S.S
DIAPHRAGM / O-RING	TEFLON [®] (DIAPHRAGM SEAL)	NBR, VITON [®] (O-RING SEAL)

► Other special materials are available upon customer's request.

BASIC ORDERING INFORMATION

1. Model and Type
2. Tank Diameter and Height
3. Tank Type
4. Design Pressure of the tank
5. Fluid Handling
6. Size and Connection
7. Material

MODEL SEB EMERGENCY VENT

Sewon SEB Conventional Emergency Vent

NOMINAL SIZE

- 16", 18", 20", and 24"
- Other sizes or specifications are available upon request.

CONNECTIONS

- API 650 Flange drilling
(For 20" & 24" only)
- ANSI/ASME 150Lbs Flange drilling
- KS/JIS 5K Flange drilling
- KS/JIS 10K Flange drilling

Enables emergency relief when fire exposure
Remains closed position when normal operating condition
The design also allows convenient access through the vent for tank inspection and maintenance
Air-cushion pallet reduces the vapor leakage from storage tank

Drilling conforming to API 650, ANSI/ASME B16.5 for class 150 flanges, or KS/JIS 5K/10K flanges. Other standards are available on customer's request.
Consult our factory for special application or special design.



SPECIFICATIONS

Installation	Vertical
Type	Weight loaded, conventional vent with hinge mechanism
Set pressure	Maximum 700mmH ₂ O

MATERIALS

PART NAME	MATERIALS	
	STANDARD	OPTIONAL
BODY	CARBON STEEL, 304 S.S, 316 S.S, ALUMINUM	HASTELLOY [®] , ALLOY 20, FRP, PTFE, ETFE LINED
PALLET	304 S.S, 316 S.S	HASTELLOY [®] , ALLOY 20, FRP, PTFE, ETFE LINED
WEIGHT	A36	304 S.S
DIAPHRAGM / O-RING	TEFLON [®] (DIAPHRAGM SEAL)	NBR, VITON [®] (O-RING SEAL)

► Other special materials are available upon customer's request.

BASIC ORDERING INFORMATION

1. Model and Type
2. Tank Diameter and Height
3. Tank Type
4. Design Pressure of the tank
5. Fluid Handling
6. Size and Connection
7. Material

MODEL SEV EMERGENCY VENT

Sewon SEV Conventional Emergency Vent

NOMINAL SIZE

- 16", 18", 20", and 24"
- Other sizes or specifications are available upon request.

CONNECTIONS

- API 650 Flange drilling
(For 20" & 24" only)
- ANSI/ASME 150Lbs Flange drilling
- KS/JIS 5K Flange drilling
- KS/JIS 10K Flange drilling

Incorporates a vacuum relief, and enables pressure and vacuum relief when emergency condition

Designed to open and provide pressure relief beyond the capacity of the normal breather vents

Remains closed position when normal operating condition

Air-cushion pallet reduces the vapor leakage from storage tank

Drilling conforming to API 650, ANSI/ASME B 16.5 for class 150 flanges, or KS/JIS 5K/10K flanges.

Other standards are available on customer's request.

Consult our factory for special application or special design.



SPECIFICATIONS

Installation	Vertical
Type	Weight loaded, conventional emergency pressure and vacuum relief vent
Set pressure / Set vacuum	Maximum 700mmH ₂ O

MATERIALS

PART NAME	MATERIALS	
	STANDARD	OPTIONAL
BODY	CARBON STEEL, 304 S.S, 316 S.S, ALUMINUM	HASTELLOY [®] , ALLOY 20, FRP, PTFE, ETFE LINED
PALLET	304 S.S, 316 S.S	HASTELLOY [®] , ALLOY 20, FRP, PTFE, ETFE LINED
WEIGHT	A36	304 S.S
DIAPHRAGM / O-RING	TEFLON [®] (DIAPHRAGM SEAL)	NBR, VITON [®] (O-RING SEAL)
WEATHER HOOD	304 S.S, ALUMINUM	316 S.S

► Other special materials are available upon customer's request.

BASIC ORDERING INFORMATION

1. Model and Type
2. Tank Diameter and Height
3. Tank Type
4. Design Pressure of the tank
5. Fluid Handling
6. Size and Connection
7. Material

MODEL SEVH EMERGENCY VENT

Sewon SEVH Conventional Emergency Vent

NOMINAL SIZE

- 16", 18", 20", and 24"
- Other sizes or specifications are available upon request.

CONNECTIONS

- API 650 Flange drilling
(For 20" & 24" only)
- ANSI/ASME 150Lbs Flange drilling
- KS/JIS 5K Flange drilling
- KS/JIS 10K Flange drilling

Enables pressure and vacuum relief when emergency condition
Remains closed position when normal operating condition
Air-cushion pallet reduces the vapor leakage from storage tank
Pallet assembly closes and reseats when the pressure is reduced

Drilling conforming to API 650, ANSI/ASME B16.5 for class 150 flanges, or KS/JIS 5K/10K flanges. other standards are available on customer's request.
Consult our factory for special application or special design.



SPECIFICATIONS

Installation Type	Vertical Weight loaded, conventional emergency Pressure and vacuum relief vent with hinge mechanism
Set pressure / Set vacuum	Maximum 700mmH ₂ O

MATERIALS

PART NAME	MATERIALS	
	STANDARD	OPTIONAL
BODY	CARBON STEEL, 304 S.S, 316 S.S, ALUMINUM	HASTELLOY [®] , ALLOY 20, FRIP, PTFE, ETFE LINED
PALLET	304 S.S, 316 S.S	HASTELLOY [®] , ALLOY 20, FRIP, PTFE, ETFE LINED
WEIGHT	A36	304 S.S
DIAPHRAGM / O-RING	TEFLON [®] (DIAPHRAGM SEAL)	NBR, VITON [®] (O-RING SEAL)
WEATHER HOOD	304 S.S, ALUMINUM	316 S.S

► Other special materials are available upon customer's request.

BASIC ORDERINF INFORMATION

1. Model and Type
2. Tank Diameter and Height
3. Tank Type
4. Design Pressure of the tank
5. Fluid Handling
6. Size and Connection
7. Material

MODEL SEAS EMERGENCY VENT

Sewon SEAS Spring Loaded Emergency Vent

NOMINAL SIZE

- 16", 18", 20", and 24"
- Other sizes or specifications are available upon request.

CONNECTIONS

- API 650 Flange drilling
(For 20" & 24" only)
- ANSI/ASME 150Lbs Flange drilling
- KS/JIS 5K Flange drilling
- KS/JIS 10K Flange drilling

Enables pressure relief when emergency condition
Remains closed position when normal operating condition
Reseats when the over-pressure has been dissipated

Drilling conforming to API 650, ANSI/ASME B 16.5 for class 150 flanges, or KS/JIS 5K/10K flanges.

Other standards are available on customer's request.

Consult our factory for special application or special design.



SPECIFICATIONS

Installation	Vertical
Type	Spring loaded
Set pressure	1 PSI to 15 PSI

MATERIALS

PART NAME	MATERIALS	
	STANDARD	OPTIONAL
BODY	CARBON STEEL, 304 S.S, 316 S.S	HASTELLOY®, ALLOY 20, FRP, PTFE, ETFE LINED
PALLET	304 S.S, 316 S.S	HASTELLOY®, ALLOY 20, FRP, PTFE, ETFE LINED
O-RING	VITON®	NBR, HNBR
SPRING	304 S.S	316 S.S

► Other special materials are available upon customer's request.

BASIC ORDERING INFORMATION

1. Model and Type
2. Tank Diameter and Height
3. Tank Type
4. Design Pressure of the tank
5. Fluid Handling
6. Size and Connection
7. Material

Teflon® is registered trademark of the Dupont Company.

Viton® is registered trademark of DuPont Dow Elastomers.

EMERGENCY VENT, PRESSURE RELIEF

Set Pressure		Air Flow Rates at 100% overpressure (Double of Set Pressure) in 1,000 Nm ³ /h			
mmH ₂ O	mbar	16"	18"	20"	24"
75	7.4	12.799	16.935	20.277	29.308
100	9.8	14.698	19.304	23.316	33.802
125	12	16.420	21.473	26.047	37.810
150	15	17.995	23.476	28.532	41.437
175	17	19.448	25.338	30.817	44.760
200	20	20.799	27.083	32.938	47.839
225	22	22.065	28.728	34.926	50.721
250	25	23.258	30.286	36.802	53.441
275	27	24.389	31.770	38.583	56.024
300	29	25.467	33.188	40.285	58.493
325	32	26.500	34.548	41.917	60.862
350	34	27.492	35.857	43.489	63.145
375	37	28.409	37.118	45.007	65.351
400	39	29.374	38.337	46.477	67.487
425	42	30.271	39.518	47.904	69.560
450	44	31.142	40.662	49.290	71.573
500	49	32.816	42.851	51.952	75.440
600	59	35.929	46.881	56.893	82.601
700	69	38.780	50.512	61.391	89.092

Notes

- Flow rates listed in above Table are based on full open valves at 100% overpressure.
- If the set pressure is not listed above Table, use liner interpolation.
- If the overpressure is less than 100%, calculate the flow rates using the Factor "C"

Example of Flow Rate Calculation

Model SEB 24"

Set pressure(P_{set})=200mmH₂O(20mbar)

Valve inlet pressure(P_{in})=265mmH₂O

- Calculate overpressure

$$\text{Overpressure} = \frac{P_{in} - P_{set}}{P_{set}} \times 100 = 33(\%)$$

- Determine Factor C from right Table C=0.82

- Read flow rate at 100%

overpressure corresponding specified set pressure. The flow rate is 47,839Nm³/h from above Table.

- Calculate flow rate at specified inlet pressure Flow rate at 265mmH₂O=0.82×47,839=39,228Nm³/h

Factor C for less than 100% over-pressure										
%	0	1	2	3	4	5	6	7	8	9
10	0.70	0.71	0.73	0.74	0.74	0.75	0.76	0.76	0.77	0.77
20	0.78	0.78	0.78	0.79	0.79	0.79	0.80	0.80	0.80	0.81
30	0.81	0.81	0.82	0.82	0.82	0.83	0.83	0.83	0.83	0.84
40	0.84	0.84	0.85	0.85	0.85	0.85	0.86	0.86	0.86	0.87
50	0.87	0.87	0.87	0.88	0.88	0.88	0.89	0.89	0.89	0.89
60	0.90	0.90	0.90	0.91	0.91	0.91	0.91	0.92	0.92	0.92
70	0.92	0.93	0.93	0.93	0.94	0.94	0.94	0.94	0.95	0.95
80	0.95	0.95	0.96	0.96	0.96	0.96	0.97	0.97	0.97	0.98
90	0.98	0.98	0.98	0.99	0.99	0.99	0.99	1.00	1.00	1.00

EMERGENCY VENT, VACUUM RELIEF

Set Vacuum		Air Flow Rates at 100% overpressure (Double of Set Vacuum) in 1,000 Nm ³ /h			
mmH ₂ O	mbar	16"	18"	20"	24"
-22	-2.2	2.438	2.438	2.438	2.438
-25	-2.5	2.582	2.582	2.582	2.582
-50	-4.9	3.627	3.627	3.627	3.627
-75	-7.4	4.459	4.459	4.459	4.459
-100	-9.8	5.148	5.148	5.148	5.148
-125	-12	5.741	5.741	5.741	5.741
-150	-15	6.266	6.266	6.266	6.266
-175	-17	6.743	6.743	6.743	6.743
-200	-20	7.183	7.183	7.183	7.183
-225	-22	7.595	7.595	7.595	7.595
-250	-25	7.983	7.983	7.983	7.983
-275	-27	8.352	8.352	8.352	8.352
-300	-29	8.703	8.703	8.703	8.703
-325	-32	9.039	9.039	9.039	9.039
-350	-34	9.360	9.360	9.360	9.360
-375	-37	9.668	9.668	9.668	9.668
-400	-39	9.964	9.964	9.964	9.964
-450	-44	10.520	10.520	10.520	10.520
-500	-49	11.033	11.033	11.033	11.033
-550	-54	11.507	11.507	11.507	11.507
-600	-59	11.944	11.944	11.944	11.944
-700	-69	12.720	12.720	12.720	12.720

Notes

- Flow rates listed in above Table are based on full open valves at 100% negative overpressure.
- If the set vacuum is not listed above Table, use liner interpolation.
- If the negative overpressure is less than 100%, calculate the flow rates using the Factor "C"

Example of Flow Rate Calculation

Model SEV 20"

Set Vacuum(P_{set})=-25mmH₂O(-2.5mbar)

Valve inlet pressure(P_{in})=-38mmH₂O

- Calculate overpressure

$$\text{Overpressure} = \frac{P_{in} - P_{set}}{P_{set}} \times 100 = 52(\%)$$

- Determine Factor C from right Table C=0.63

- Read flow rate at 100%

negative overpressure corresponding specified set Vacuum. The flow rate is 2,582Nm³/h from above Table.

- Calculate flow rate at specified inlet pressure Flow rate at -38mmH₂O=0.63 × 2,582=1,627Nm³/h

Factor C for less than 100% negative over-pressure										
%	0	1	2	3	4	5	6	7	8	9
10	-	-	-	-	-	0.20	0.21	0.23	0.24	0.25
20	0.27	0.28	0.29	0.31	0.32	0.33	0.35	0.36	0.37	0.39
30	0.40	0.41	0.42	0.43	0.45	0.46	0.47	0.48	0.49	0.50
40	0.51	0.52	0.53	0.54	0.56	0.57	0.58	0.59	0.60	0.61
50	0.62	0.62	0.63	0.64	0.65	0.66	0.67	0.68	0.69	0.70
60	0.71	0.72	0.72	0.73	0.74	0.75	0.76	0.77	0.77	0.78
70	0.79	0.80	0.81	0.81	0.82	0.83	0.84	0.84	0.85	0.86
80	0.87	0.87	0.88	0.89	0.89	0.90	0.91	0.91	0.92	0.93
90	0.93	0.94	0.95	0.95	0.96	0.97	0.97	0.98	0.99	0.99

EMERGENCY VENT, PRESSURE RELIEF

Set Pressure		Air Flow Rates at 100% overpressure (Double of Set Pressure) in 1,000 Nm ³ /h			
mmH ₂ O	mbar	16"	18"	20"	24"
750	74	18.248	23.586	28.487	40.935
800	78	18.804	24.304	29.366	42.192
850	83	19.349	25.008	30.226	43.422
900	88	19.882	25.698	31.067	44.628
950	93	20.405	26.374	31.891	45.809
1,000	98	20.917	27.037	32.699	46.967
1,100	108	21.911	28.323	34.265	49.215
1,200	118	22.868	29.562	35.770	51.378
1,300	127	23.790	30.755	37.219	53.462
1,400	137	24.679	31.907	38.616	55.472
1,500	147	25.537	33.020	39.964	57.413
1,750	172	27.564	35.646	43.141	61.992
2,000	196	29.439	38.078	46.078	66.228
2,500	245	32.828	42.473	51.376	73.867
3,000	294	35.843	46.380	56.083	80.643
5,000	490	45.654	59.076	71.392	102.607
7,500	735	55.167	71.390	86.269	124.015
8,000	785	56.829	73.546	88.872	127.792
10,000	981	62.834	81.358	98.292	141.588

Notes

- Flow rates listed in above Table are based on full open valves at 100% overpressure.
- If the set pressure is not listed above Table, use liner interpolation.
- If the overpressure is less than 100%, calculate the flow rates using the Factor "C"

Example of Flow Rate Calculation

Model SEAS 24"

Set pressure(P_{set})=1,200mmH₂O(118mbar)

Valve inlet pressure(P_{in})=1,600mmH₂O

- Calculate overpressure

$$\text{Overpressure} = \frac{P_{in} - P_{set}}{P_{set}} \times 100 = 33(\%)$$

- Determine Factor C from right Table C=0.43

- Read flow rate at 100% overpressure corresponding specified set pressure. The flow rate is 51,378Nm³/h from above Table.

- Calculate flow rate at specified inlet pressure Flow rate at 1,600mmH₂O=0.43 × 51,378=22,093Nm³/h

Factor C for less than 100% over-pressure										
%	0	1	2	3	4	5	6	7	8	9
10	-	-	-	-	-	0.20	0.21	0.23	0.24	0.25
20	0.27	0.28	0.29	0.31	0.32	0.33	0.35	0.36	0.37	0.39
30	0.40	0.41	0.42	0.43	0.45	0.46	0.47	0.48	0.49	0.50
40	0.51	0.52	0.53	0.54	0.56	0.57	0.58	0.59	0.60	0.61
50	0.62	0.62	0.63	0.64	0.65	0.66	0.67	0.68	0.69	0.70
60	0.71	0.72	0.72	0.73	0.74	0.75	0.76	0.77	0.77	0.78
70	0.79	0.80	0.81	0.81	0.82	0.83	0.84	0.84	0.85	0.86
80	0.87	0.87	0.88	0.89	0.89	0.90	0.91	0.91	0.92	0.93
90	0.93	0.94	0.95	0.95	0.96	0.97	0.97	0.98	0.99	0.99

DIMENSIONS

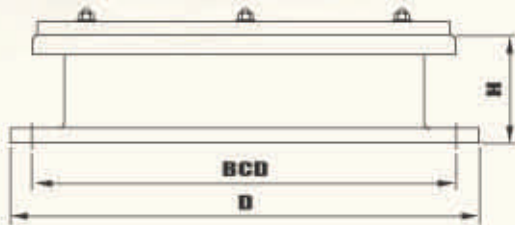

MODEL SEA

Size (Inch)	API 650 ("Inch unit)		API 650 ("mm unit)		ANSI 150Lb		H (mm)	Approx. Weight(kg) (At Min.setting)	
	BCD (mm)	D (mm)	BCD (mm)	D (mm)	BCD (mm)	D (mm)		C.S	Aluminum
16"	-	-	-	-	539.8	596.9	110	-	-
18"	-	-	-	-	577.9	635.0	110	-	-
20"	596.9	660.4	590	650	635.0	698.5	110	60	34
24"	698.5	762.0	690	750	749.3	812.8	110	100	53

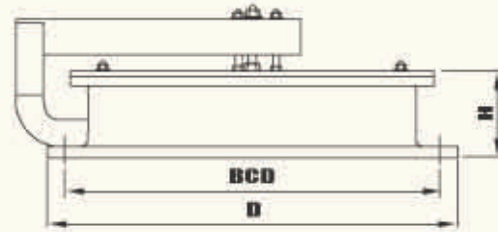

MODEL SEB

Size (Inch)	API 650 ("Inch unit)		API 650 ("mm unit)		ANSI 150Lb		H (mm)	Approx. Weight(kg) (At Min.setting)	
	BCD (mm)	D (mm)	BCD (mm)	D (mm)	BCD (mm)	D (mm)		C.S	Aluminum
16"	-	-	-	-	539.8	596.9	110	-	-
18"	-	-	-	-	577.9	635.0	110	-	-
20"	596.9	660.4	590	650	635.0	698.5	110	64	34
24"	698.5	762.0	690	750	749.3	812.8	110	100	53

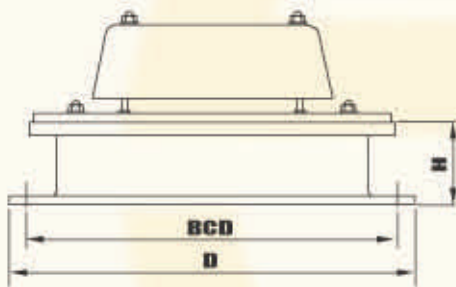

MODEL SEV

Size (Inch)	API 650 ("Inch unit)		API 650 ("mm unit)		ANSI 150Lb		H (mm)	Approx. Weight(kg) (At Min.setting)	
	BCD (mm)	D (mm)	BCD (mm)	D (mm)	BCD (mm)	D (mm)		C.S	Aluminum
16"	-	-	-	-	539.8	596.9	110	-	-
18"	-	-	-	-	577.9	635.0	110	-	-
20"	596.9	660.4	590	650	635.0	698.5	110	60	41
24"	698.5	762.0	690	750	749.3	812.8	110	100	55

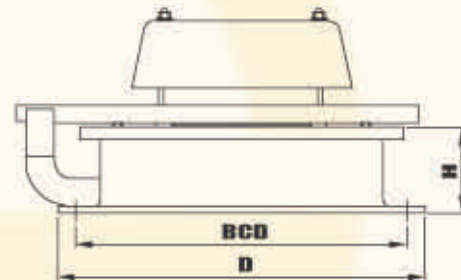

MODEL SEVH

Size (Inch)	API 650 ("Inch unit)		API 650 ("mm unit)		ANSI 150Lb		H (mm)	Approx. Weight(kg) (At Min.setting)	
	BCD (mm)	D (mm)	BCD (mm)	D (mm)	BCD (mm)	D (mm)		C.S	Aluminum
16"	-	-	-	-	539.8	596.9	110	-	-
18"	-	-	-	-	577.9	635.0	110	-	-
20"	596.9	660.4	590	650	635.0	698.5	110	60	48
24"	698.5	762.0	690	750	749.3	812.8	110	100	59

DIMENSIONS

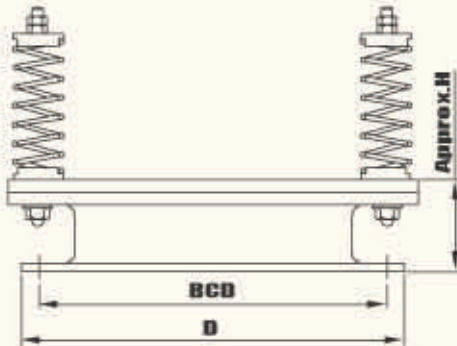

MODEL SEAS





Size (Inch)	API 650 (Inch unit)		API 650 (mm unit)		ANSI 150Lb		H (mm)	Approx. Weight(kg) (At Min.setting)	
	BCD (mm)	D (mm)	BCD (mm)	D (mm)	BCD (mm)	D (mm)		C.S	Aluminum
16"	-	-	-	-	539.8	596.9	130	-	-
18"	-	-	-	-	577.9	635.0	130	-	-
20"	596.9	660.4	590	650	635.0	698.5	130	135	85
24"	698.5	762.0	690	750	749.3	812.8	130	180	100

Notes

The overall height may change with set pressure.

Actual dimensions may vary from these listed dimensions due to variations or revisions of specifications, and may change without notice. For more information, consult our factory.

HOW TO ORDER

MODEL	INLET SIZE	MATERIALS	FLANGE DRILLING	OPTION
 SEA SEB SEV SEVH SEAS	 16 : 16" 18 : 18" 20 : 20" 24 : 24" SS : Special	 Pallet Body C : Carbon Steel 4 : 304 S.S 5 : 304L S.S 6 : 316 S.S 7 : 316L S.S A : Aluminum S : Special Material	 PO : API 650 '98 Edition in Inch Unit PN : API 650 '98 Edition in Metric Unit AR : ANSI Class 150 RF AF : ANSI Class 150 FF KR : KS/JIS 10K RF KF : KS/JIS 10K FF 5F : KS/JIS 5K FF 5R : KS/JIS 5K RF NO : NO Drilling SS : Special	 O : No Option 4 : 304SS weight 6 : 316SS weight S : Special

EXAMPLE

SEA-24-C4-PN-0

Means a 24" model SEA emergency vent with carbon steel body, 304 SS pallet, API 650 '98 Edition flange drilling and no other option.

SEWON GAUGE HATCH & ROOF MANHOLE COVER

Gauge Hatch: 4"-10" ●

Roof Manhole Cover: 24",30",& 36" ●

SEWON Q&TECH CO.,LTD.

■ HEAD OFFICE/FACTORY

103B-2, CHUNGOK-RI, JUCHON-MYUN, KIMHAE,
KYEONG-NAM,KOREA.621-840
Tel: +82-55-323-5894~7
Fax: +82-55-323-5898
<http://www.swqt.co.kr>
<http://www.sewon-hnd.co.kr>
E-mail:helpdesk@swqt.co.kr

■ SEOUL OFFICE

3FL, 29-13, KARAK-DONG, SONGPA-KU,
SEOUL,KOREA.138-160
Tel: +82-2-406-5013~4/406-7021
Fax: +82-2-406-7022
E-mail:helpdesk@swqt.co.kr



MODEL SGH GAUGE HATCH

Sewon SGH Gauge Hatch

NOMINAL SIZE

- Other 4", 6", 8", and 10"

CONNECTIONS

- ANSI/ASME B16.5 Class 150 Flange
- KS/JIS 10K Flange

Enable easy access to check level, temperature and sampling
TEFLON[®] Seat is SEWON standard to minimize sticking caused by resinous vapors and atmospheric moisture Included a foot pedal for easy opening, and designed spark-proof Simple structure enable easy maintenance, and reduce maintenance cost.

Non-sparking design and gas tight to 1 PSI Available in NBR, VITON and other elastomers, metal-to-metal seat can be provided when required Weight loaded cover model provides pressure relief as well as supplemental emergency venting capacity Drilling conforming to ANSI/ASME B 16.5 for class 150 flanges, or KS/JIS 10K flanges.



Other standards are available on customer's request

- Consult our factory for special application

SPECIFICATIONS

Maximum Working Pressure	200mbar(g) (3psi)for Lockdown type
Type	Non-sparking, lockdown type weight loaded type(optional)

- Other specifications are available. consult our factory.

MATERIALS

PART NAME	MATERIALS	
	STANDARD	OPTIONAL
BODY	CARBON STEEL, 304 S.S, 316 S.S, ALUMINUM	HASTELLOY [®] , ALLOY 20
SEAT MATERIAL	PTFE TEFLON [®]	NBR, VITON [®]
EYE BOLT & BUTTFLY NUT	304 S.S	-
HINGE PIN	304 S.S	-

- Other special materials such as Hastelloy[®] B/C & Alloy 20 are available upon customer's request.

MODEL SGH ROOF MANHOLE COVER

Sewon SGH Manhole Cover

NOMINAL SIZE

- 24", 30", and 36"

CONNECTIONS

- ANSI/ASME B16.5 Class 150 Flange(24")
- KS/JIS 10K Flange
- API 650 Flange(24")
- ANSI/ASME B 16.47, MSS SP44(30" or 36")

Roof manways provide easy entry for maintenance or inspection needs
Non-sparking design and gas tight to 1 PSI
Available in NBR, VITON and other elastomers
Drilling conforming to ANSI/ASME B 16.5 for class 24" 150 flanges, ANSI/ASME B 16.47 for 30" & 36" 150 flanges, or KS/JIS 10K flanges.
Other standards are available on customer's request

► Consult our factory for special application.



SPECIFICATIONS

Maximum Working Pressure
Type

70mbar(g) (1psi)

Non-sparking, Lock-down mechanism

► Other specifications are available. Consult our factory.

MATERIALS

PART NAME	MATERIALS	
	STANDARD	OPTIONAL
BODY	CARBON STEEL, 304 S.S, 316 S.S, ALUMINUM	HASTELLOY [®] , ALLOY 20
SEAT MATERIAL	TEFLON	VITON [®]
EYE BOLT & BUTTELY NUT	304 S.S	-
HINGE PIN	304 S.S	-

► Other Special materials such as Hastelloy[®] B/C & Alloy 20 are available upon customer's request.

BASIC ORDERING INFORMATION

1. Model and Type
2. Fluid Handling
3. Operating Temperature & Pressure ranges
4. Size and Connection
5. Material

Teflon[®] is registered trademark of the Dupont Company.
Viton[®] is registered trademark of DuPont Dow Elastomers.
Hastelloy[®] is the registered trademark of Haynes International, Inc.

DIMENSIONS

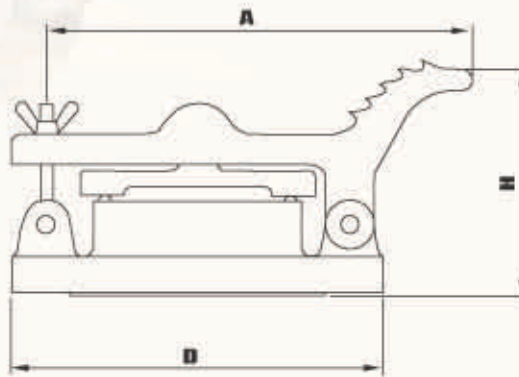

MODEL SGH

Size (inch)	H (mm)	D (mm)	Approx.A (mm)	Approx. Weight [Kg]	
				C.S	Aluminum
4"	117	228.6	261	15	5
6"	117	279.4	312	18	7
8"	122	342.9	375	32	9
10"	126	406.4	429	37.5	12
12"~	CONSULT FACTORY				

Notes

The overall height may change with flange specification.

Actual dimensions may vary from these listed dimensions due to variations or revisions of specifications, and may change without notice. For more information, consult our factory.

HOW TO ORDER

MODEL	INLET SIZE	MATERIALS	FLANGE DRILLING	OPTION
 SGH	 04 : 04" 06 : 06" 08 : 08" 10 : 10" 24 : 24" 30 : 30" 36 : 36" SS : Special	 C : Carbon Steel 4 : 304 S.S 5 : 304L S.S 6 : 316 S.S 7 : 316L S.S A : Aluminum S : Special Material	 AR : ANSI Class 150 RF AF : ANSI Class 150 FF KR : KS/JIS 10K RF KF : KS/JIS 10K FF NO : NO Drilling SS : Special	 Others Seat Material T : PTFE Teflon® N : NBR(Buna-N)O-ring V : Viton® O-Ring M : Metal to Metal O : No Option S : Special

EXAMPLE

SGH-06-A-AF-TO

Means a 6" model SGH gauge hatch with aluminum body, ANSI Class 150 FF flange drilling, PTFE Teflon seat and no other option.

Teflon® is registered trademark of the Dupont Company.

Viton® is registered trademark of DuPont Dow Elastomers.

SEWON BLANKETING DEVICE

MODEL SNB 110 ●

MODEL SNB 210 ●



SEWON Q&TECH CO.,LTD.

■ HEAD OFFICE/FACTORY

1038-2, CHUNGOK-RI, JUCHON-MYUN, KIMHAE,
KYEONG-NAM, KOREA, 621-840
Tel: +82-55-323-5894~7
Fax: +82-55-323-5898
<http://www.swqt.co.kr>
<http://www.sewon-IND.co.kr>
E-mail: helpdesk@swqt.co.kr

■ SEOUL OFFICE

3FL, 29-13, KARAK-DONG, SONGPA-KU,
SEOUL, KOREA, 138-160
Tel: +82-2-406-5013~4/406-7021
Fax: +82-2-406-7022
E-mail: helpdesk@swqt.co.kr

MODEL SNB 110/210

BLANKETING DEVICE

The Sewon Inert Gas Blanket Device ensures that a constant gas pressure is maintained in the vapor space of a storage tank.

When liquid is discharged from a storage tank or the temperature is reduced, a vacuum would be developed. With the Sewon Inert Gas Blanket Device, a blanket gas is supplied to prevent any vacuum from developing and to maintain the desired blanket pressure. In addition to, preventing outside air and moisture from entering the storage vessel, and reduces the evaporation of the stored product to a negligible amount.

The result not only conserves product but also greatly reduces emissions. These advantages are in addition to the fire protection that is provided.

The simple design of a Sewon Inert Gas Blanket Device eliminates the need for a multiple regulator system or the complicated pilot operated blanketing valves.

By utilizing a regulator with totally balanced chambers, maintenance will also be reduced. The balanced design means that you will have high accuracy, reliability.

BLANKETING DEVICE

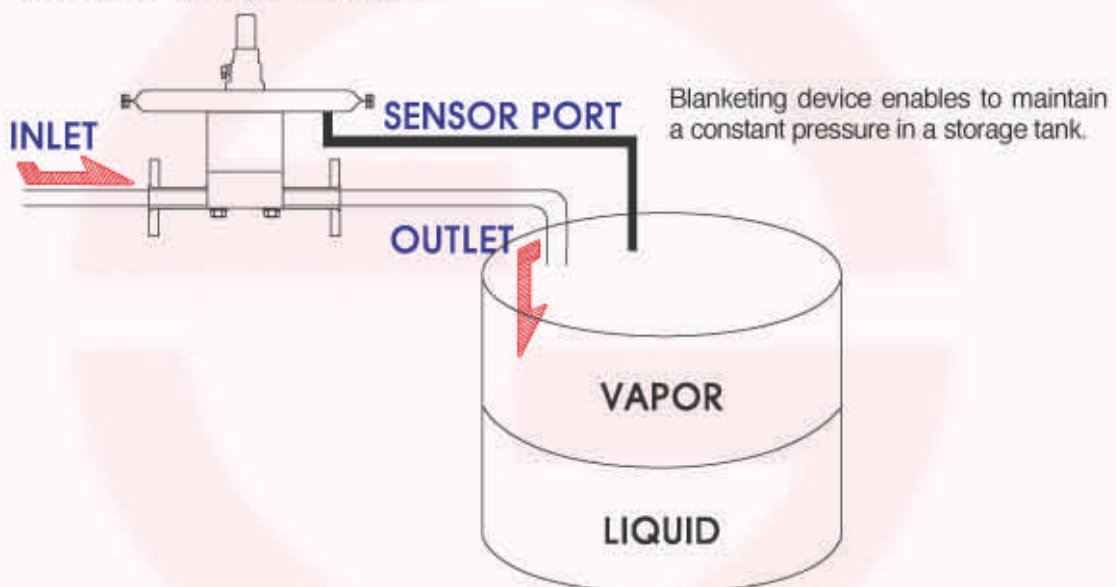

THE MAJOR BENEFIT OF USING THIS DEVICE

- **Reduce explosion risk and evaporation loss**
Provides a head pressure above the liquid to reduce evaporation loss, and it helps protect the inside tank corrosion.
- **Maintain a constant pressure and precise pressure control**
Prevent outside air, moisture, and other contaminants from entering the storage tank by means of maintaining a constant pressure in the tank.
- **Protect chemical in a storage tank from oxidation**
- **Vacuum relief function**
Provides a function as venting device(Vacuum relief device)

INSTALLATION

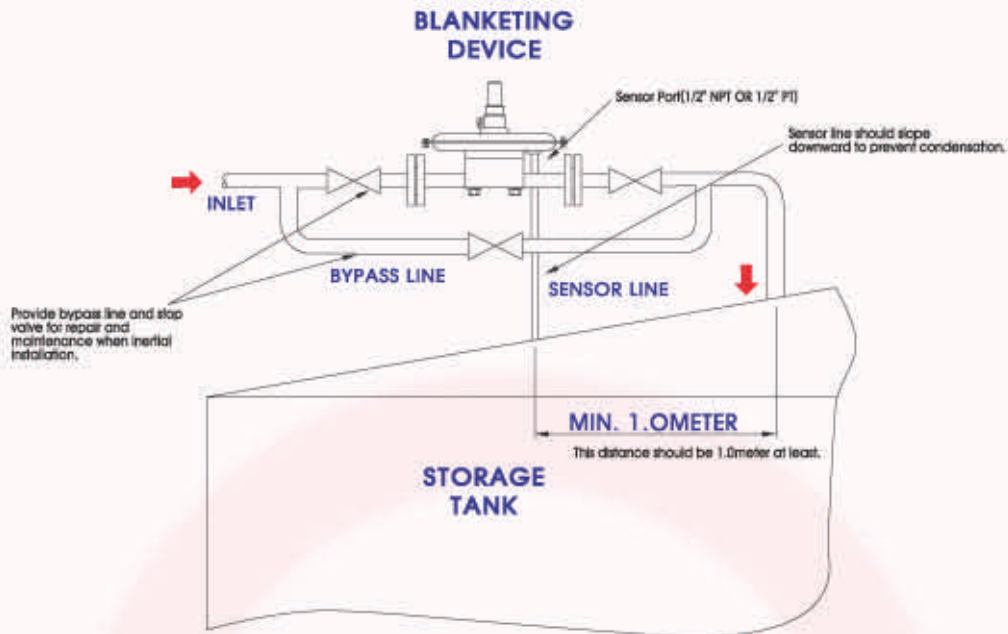

OPERATION PRINCIPLE

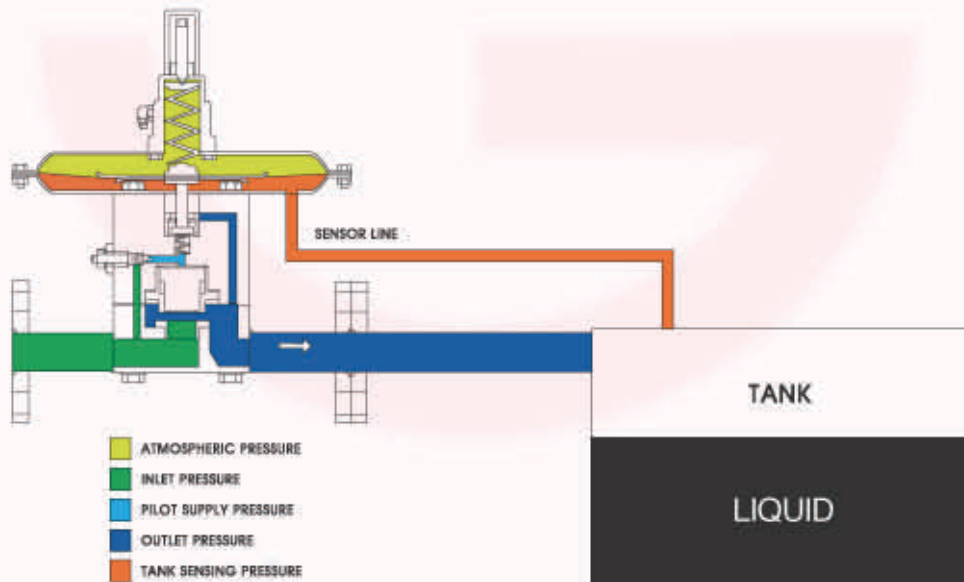

Tank Pressure is sensed on the underside of the diaphragm. The Diaphragm directly actuates the pilot valve, Flow through the pilot valve is directed to the pilot valve causes the pressure to drop in the sealed chamber above the main valve piston. When the pressure has dropped sufficiently, the main valve opens and allows blanketing gas to flow into the tank. When the pressure is restored the pilot closes. Pilot flow ceases and restores the pressure above the main valve piston to full inlet pressure shutting off the main valve. This full balancing of forces is essential if the pilot valve is not to be unduly influenced by change in inlet pressure.

DIMENSIONS

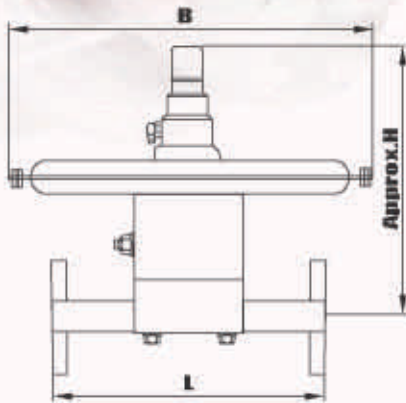

MODEL - SNB210

B (mm)	L (mm)	H (mm)	WEIGHT (kg)	MINIMUM SET PRESSURE	REMARKS
300	300	300	17.5	+12.5mmH ₂ O	without inlet pressure regulator
300	520	300	22	+12.5mmH ₂ O	with inlet pressure regulator

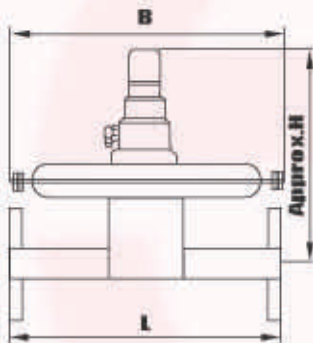

MODEL - SNB110

B (mm)	L (mm)	H (mm)	WEIGHT (kg)	MINIMUM SET PRESSURE	REMARKS
300	300	200	7	+12.5mmH ₂ O	without inlet pressure regulator
300	520	200	11.5	+12.5mmH ₂ O	with inlet pressure regulator

► The weight may vary with flange specification or inlet pressure regulator. Actual dimensions may vary from these listed dimensions due to variations or revisions of specifications. The dimensions may change without notice. For more information, consult our factory.

SPECIFICATIONS

SET PRESSURE(OPEN PRESSURE) RANGE	+12.5mmH ₂ O to +5,000mmH ₂ O
MINIMUM INLET PRESSURE	1.0kg/cm ²
OPERATING TEMPERATURE RANGE	-28 to 100 DEG. C(-18 to 212 DEG. F)
SENSOR PORT CONNECTION	1/2" NPT or 1/2"PT

Type SNB210

Type SNB210 (Connection Type : 1/2-inch)				
INLET PRESSURE				CAPACITIES IN SCFH (m ³ /h(n))
Psi	Bar	kg/cm ²	kPa	
25	1.72	1.76	172	5,049(143)
30	2.1	2.11	207	5,720(162)
40	2.8	2.81	276	7,415(210)
50	3.4	3.52	345	8,615(244)
60	4.1	4.22	414	10,098(286)
70	4.8	4.92	483	11,617(329)
80	5.5	5.62	552	13,135(372)
90	6.2	6.33	621	14,724(417)
100	6.9	7.03	690	16,242(460)
110	7.6	7.73	759	17,761(503)
120	8.3	8.44	828	19,276(546)

Type SNB210 (Connection Type : 1-inch)				
INLET PRESSURE				CAPACITIES IN SCFH (m ³ /h(n))
Psi	Bar	kg/cm ²	kPa	
25	1.72	1.76	172	12,570(356)
30	2.1	2.11	207	14,265(404)
40	2.8	2.81	276	17,690(501)
50	3.4	3.52	345	21,539(610)
60	4.1	4.22	414	25,423(720)
70	4.8	4.92	483	29,201(827)
80	5.5	5.62	552	33,015(935)
90	6.2	6.33	621	36,723(1,040)
100	6.9	7.03	690	40,607(1,150)
110	7.6	7.73	759	44,138(1,250)
120	8.3	8.44	828	48,022(1,360)

Typical accuracy when flowing 5~70% of table value is +/-15 mmAq

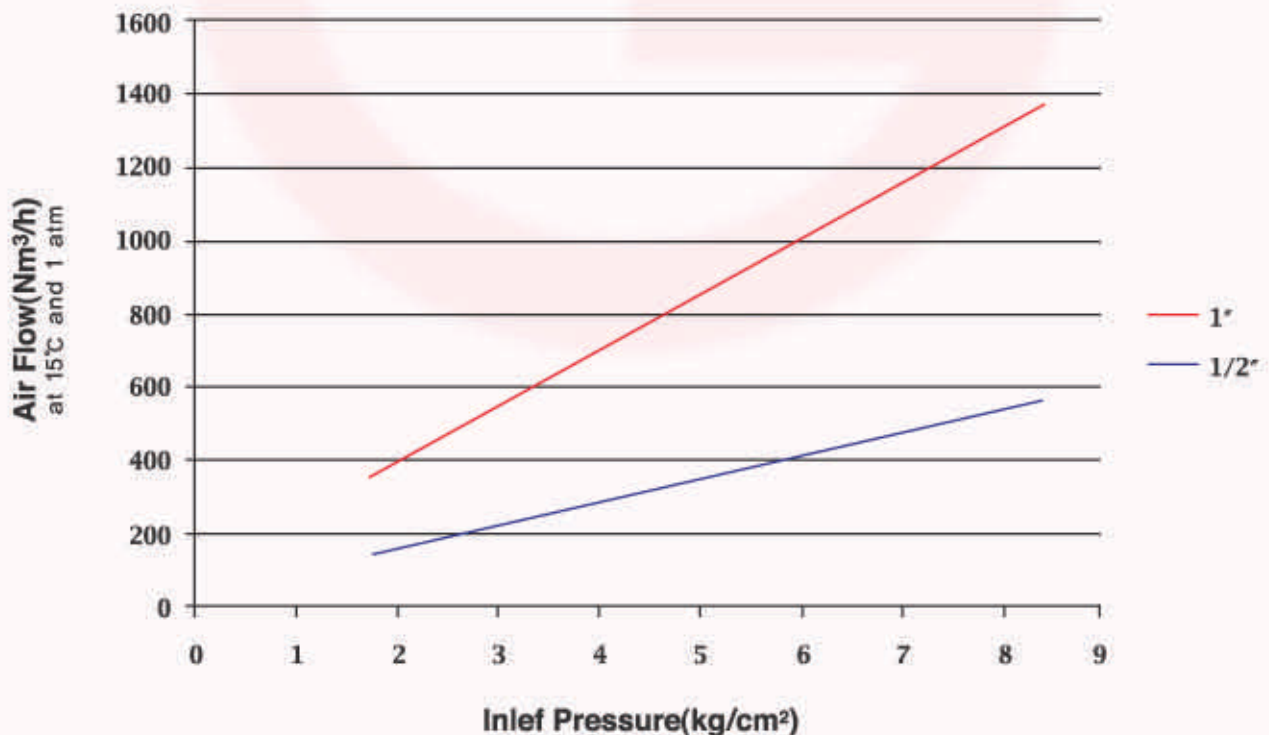

FLOW RATES

Type SNB 110

Type SNB110 (Connection Type : 1/2-inch)				
INLET PRESSURE				CAPACITIES IN SCFH (m ³ /h(n))
Psi	Bar	kg/cm ²	kPa	
25	1.72	1.76	172	236(6.7)
30	2.1	2.11	207	324(9.2)
40	2.8	2.81	276	536(15.2)
50	3.4	3.52	345	762(21.6)
60	4.1	4.22	414	999(28.3)
70	4.8	4.92	483	1242(35.2)
80	5.5	5.62	552	1483(42)

Type SNB110(Connection Type : 1-inch)				
INLET PRESSURE				CAPACITIES IN SCFH (m ³ /h(n))
Psi	Bar	kg/cm ²	kPa	
25	1.72	1.76	172	1235(35)
30	2.1	2.11	207	1412(40)
40	2.8	2.81	276	1765(50)
50	3.4	3.52	345	2153(61)
60	4.1	4.22	414	2542(72)
70	4.8	4.92	483	2895(82)
80	5.5	5.62	552	3283(93)
90	6.2	6.33	621	3672(104)
100	6.9	7.03	690	4060(115)
110	7.6	7.73	759	4413(125)
120	8.3	8.44	828	4802(136)

Typical accuracy when flowing 5~70% of table value is +/-15 mmAq

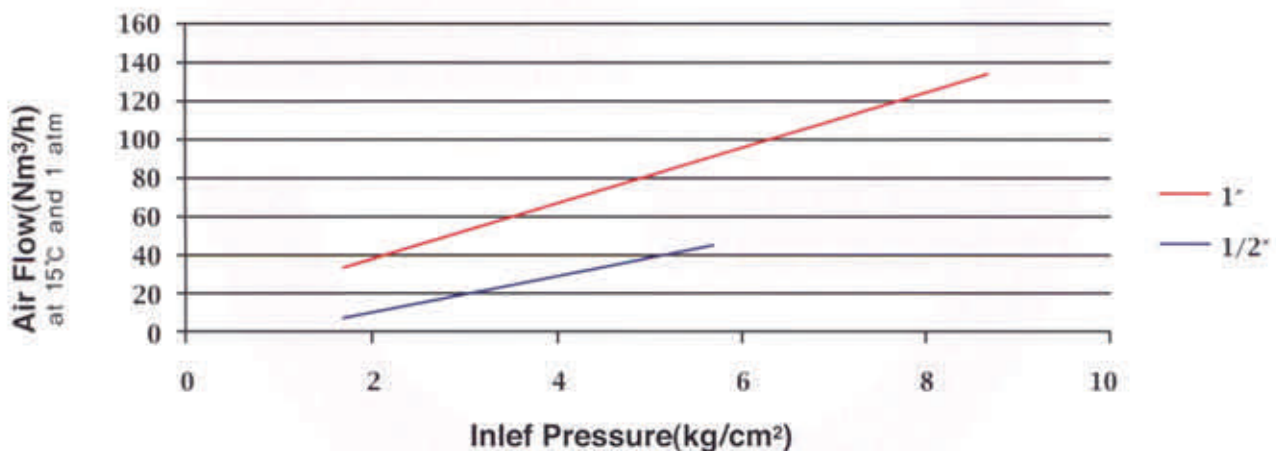

Normal Venting Capacity Requirements of API Standard 2000

	Inbreathing (Vacuum Relief)	
	Regardless of Flash Point or Boiling Point	
	Metric (m ³ /hr)	British (ft ³ /hr)
For Oil Movement	$1 \times Re$	$5.6 \times Re$
For Thermal Effect	$C \geq 3, 180m^3 = 0.61 \times (AS + Ar)$	$C \geq 20,000 \text{ bbls} = 0.61 \times (AS + Ar)$
	$C < 3, 180m^3 = 0.178 \times C$	$C < 20,000 \text{ bbls} = 1 \times C$

Venting Capacity Requirements = Oil Movement + Thermal Effect

*C : Tank Capacity

*Re : Maximum Emptying Rate

*As : Area of Shell

*Ar : Area of Roof

ORDERING GUIDE

■ End Connection Style

- ANSI CLASS 150*
- KS/JIS 10K*
- RF*
- FF*
- 1/2-inch*
- 3/4-inch*
- 1-inch*
- 2-inch*

■ Other Requirements

- INLET PRESSURE GAUGE(RANGE 0 to 10kg/cm²)
- INLET PRESSURE REGULATOR
- INLET PRESSURE REGULATOR WITH FILTER
- FLEXIBLE HOSE(FOR CONNECTION)

■ Inlet Pressure _____

■ Set Pressure _____

- Remark* Our Standard-readily Available for Shipment





■ O-RING Material

- NBR*
- VITON*
- EPDM*
- KALREZ
- OTHERS

■ Actuator Material

- S304 Stainless steel*
- S316 Stainless steel*

HOW TO ORDER

MODEL	SIZE	MATERIALS	FLANGE DRILLING	OPTION
 ↓ SNB-110 SNB-210	 ↓ 15 : 1/2" 20 : 3/4" 25 : 1" 40 : 1-1/2" 50 : 2" SS : Special	 ↓ Body ↓ Seat 4 : 304 S.S 6 : 316 S.S S : Special Material N : NBR V : Viton [®] S : Special Material	 ↓ AR : ANSI Class 150 RF AF : ANSI Class 150 FF KR : KS/JIS 10K RF KF : KS/JIS 10K FF NO : NO Drilling SS : Special	 ↓ O : No Option R : Inlet pressure regulator F : Inlet pressure regulator with filter S : Special

EXAMPLE

SNB210-25-4V-AR-0

Means a 1" (25A) model SNB-210 with 304 stainless steel body, Viton[®] seat, ANSI/ASME Class 150 RF flange and No other Option.

Teflon[®] is registered trademark of the Dupont Company.

SEWON OTHER SPECIAL PRODUCTS

FREE VENT ●

SAMPLE COOLER ●

SLOT DIPPING & SAMPLING DEVICE ●



SEWON Q&TECH CO.,LTD.

■ HEAD OFFICE/FACTORY

1038-2, CHUNGOK-RI, JUCHON-MYUN, KIMHAE,
KYEONG-NAM, KOREA, 621-840
Tel: +82-55-323-5894~7
Fax: +82-55-323-5898
<http://www.swqt.co.kr>
<http://www.sewon-ind.co.kr>
E-mail: helpdesk@swqt.co.kr

■ SEOUL OFFICE

3FL, 29-13, KARAK-DONG, SONGPA-KU,
SEOUL, KOREA, 138-160
Tel: +82-2-406-5013~4/406-7021
Fax: +82-2-406-7022
E-mail: helpdesk@swqt.co.kr

MODEL SFVG FREE VENT-GOOSE NECK TYPE

Sewon Free Vent Series

NOMINAL SIZE

- 2", 3", 4", 6", 8", 10", and 12"
- 14" through 20" sizes are available upon request

CONNECTIONS

- ANSI/ASME B16.5 Class 150 Flange
- KS/JIS 10K Flange

SEWON free vents are used on the top of storage tank containing non-flammable liquid or on the end of vent pipe.

Available in carbon steel, 304 S.S, 316 S.S and other special materials

Available in size 2" to 20"

Fitted stainless steel wire screen with flanges

May be combined with flame arrester for flammable fluid storage tanks

Drilling conforming to

ANSI/ASME B16.5 for class 150 flanges, or KS/JIS 10K flanges.

Other standards are available on customer's request.

Consult our factory for special application or special design.



SPECIFICATIONS

Installation
Type

Vertical
Goose neck type free vent

MATERIALS

PART NAME	MATERIALS	
	STANDARD	OPTIONAL
BODY	CARBON STEEL	304 S.S, 316 S.S
FLANGE	CARBON STEEL	304 S.S, 316 S.S
BIRD SCREEN	304 S.S	-

► Other Special materials are available upon customer's request.

BASIC ORDERING INFORMATION

1. Model and Type
2. Fluid Handling
3. Operating Temperature & Pressure ranges
4. Height & Diameter of tank
5. Pumping(Filling/Emptying)rates
6. Size and Connection
7. Material

MODEL SFV FREE VENT-WEATHER HOOD TYPE

Sewon Free Vent Series

NOMINAL SIZE

- 1", 2", 3", 4", 6", 8", 10", and 12"
- 14" through 20" sizes are available upon request

CONNECTIONS

- ANSI/ASME B16.5 Class 150 Flange
- KS/JIS 10K Flange

SEWON free vents are used on the top of storage tank containing non-flammable liquid or on the end of vent pipe. this model is fitted a weather hood on the vent nozzle, it enable to reduce the weight compare with goose neck type vent.

Available in carbon steel, 304 S.S, 316 S.S and other special materials compact design and simple structurer.

Available in size 1" to 20"

Fitted stainless steel bird screen

May be combined with flame arrester for flammable fluid storage tanks

Drilling conforming to ANSI/ASME B16.5 for class

150 flanges, or KS/JIS 10K flanges.

Other standards are available on customer's request.

Consult our factory for special application or special design.



SPECIFICATIONS

Installation
Type

Vertical
Free vent with stainless steel weather hood

MATERIALS

PART NAME	MATERIALS	
	STANDARD	OPTIONAL
BODY	CARBON STEEL, 304 S.S, 316 S.S, ALUMINUM	HASTELLOY®, ALLOY 20, FRP, PTFE, ETFE LINED
HOOD	304 S.S, ALUMINUM	316 S.S
BIRD SCREEN	304 S.S	-

► Other Special materials are available upon customer's request.

BASIC ORDERING INFORMATION

1. Model and Type
2. Fluid Handling
3. Operating Temperature & Pressure ranges
4. Height & Diameter of tank
5. Pumping(Filling/Emptying)rates
6. Size and Connection
7. Material

FLOW RATES, SEWON FREE VENT SERIES

FREE VENT FLOW RATES, MODEL SFVG

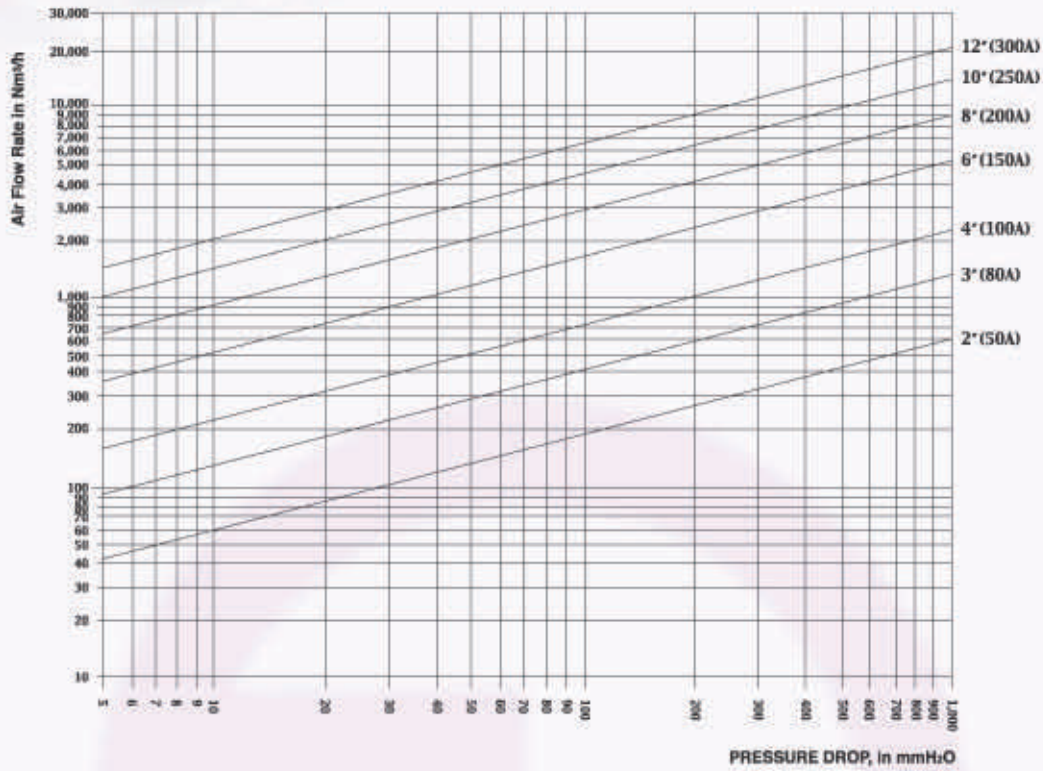

FREE VENT FLOW RATES, MODEL SFV

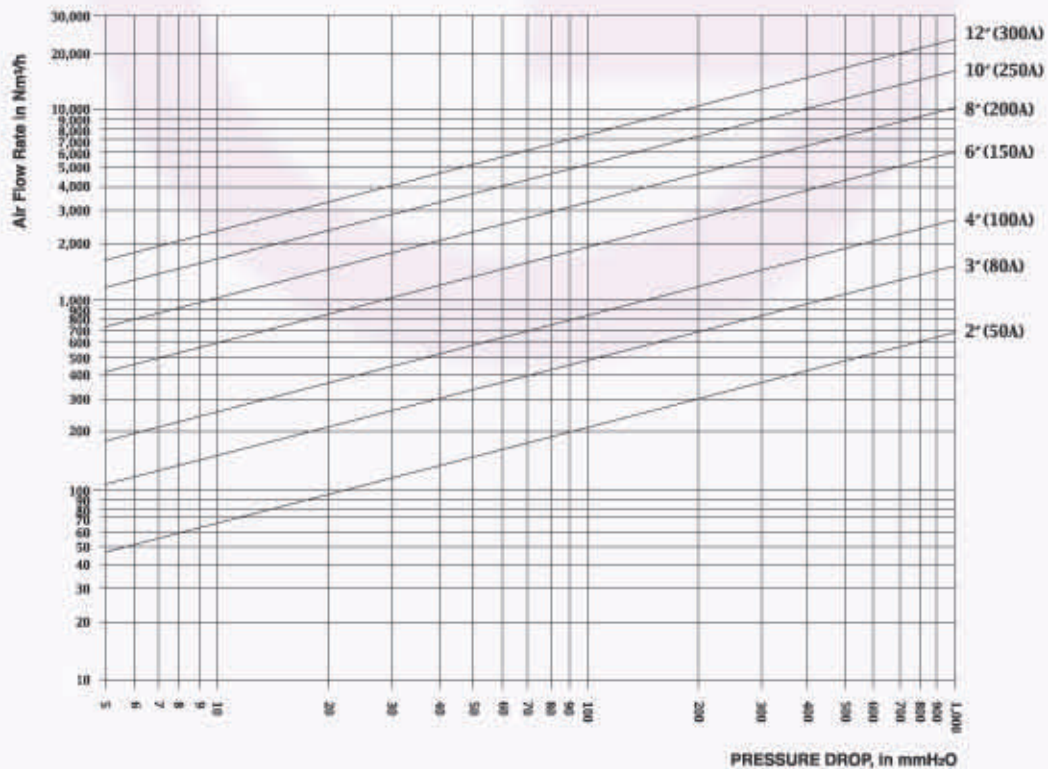

DIMENSIONS

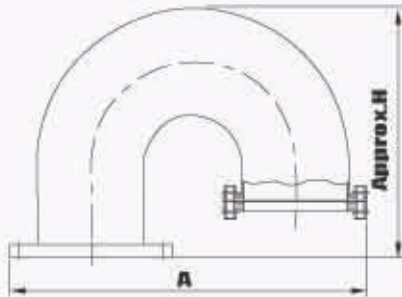

MODEL SFVG

Size (inch)	A (mm)	H (mm)	Approx. Weight [Kg]	
			C.S	
1"	-	-	-	-
2"	255	255	6.9	
3"	340	335	15.8	
4"	425	300	24	
6"	585	400	50	
8"	745	510	87.9	
10"	910	620	140	
12"	1075	740	187	

► The dimensions may vary with flange specification.

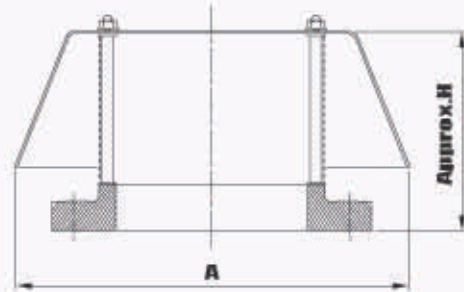

MODEL SFV

Size (inch)	A (mm)	H (mm)	Approx. Weight [Kg]	
			C.S	Aluminum
1"	200	115	3	2
2"	200	125	4	3
3"	270	130	8	5
4"	280	135	10	7
6"	345	140	14	10
8"	400	145	20	15
10"	400	150	28	21
12"	500	155	45	38

HOW TO ORDER

MODEL	SIZE	BODY MATERIALS	FLANGE DRILLING	OPTION
 SFVG SFV	 01 : 1" 02 : 2" 03 : 3" 04 : 4" 06 : 6" 08 : 8" 10 : 10" 12 : 12"	 C : Carbon Steel 4 : 304 S.S 5 : 304L S.S 6 : 316 S.S 7 : 316L S.S A : Aluminum S : Special Material	 AR : ANSI Class 150 RF AF : ANSI Class 150 FF KR : KS/JIS 10K RF KF : KS/JIS 10K FF NO : NO Drilling SS : Special	 O : No Option S : Special

EXAMPLE

SFV-08-4-AR-0

Means a 8" model SFV with 304 stainless steel body, ANSI/ASME Class 150 RF flange drilling and no other option.

SAMPLE COOLER

For cooling high temperature, high pressure liquid or gas samples suitable materials available for corrosive and extreme temperature service stainless coil is standard with rating 150 lbs to 1500lbs

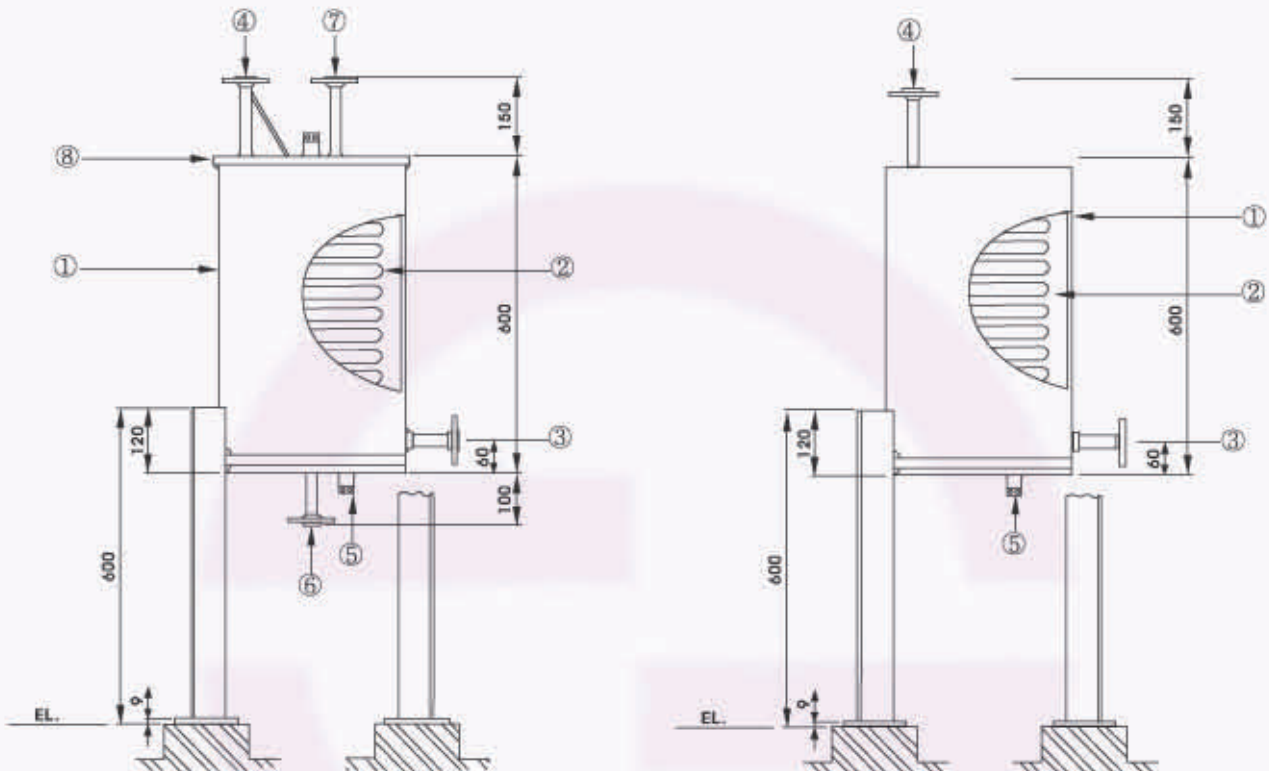

MATERIALS

NO.	PART NAME	MATERIALS	
		STANDARD	OPTIONAL
1	Shell	A53-GR, B(Carbon steel), A36	304 SS, 316 SS
2	Tube	A312-TP304	A312-TP316, A312-TP316L
3	Flange, Sample outlet	A182-F304	A182-F316, A182-F316L
4	Flange, Sample inlet	A182-F304	A182-F316, A182-F316L
5	Drain plug	Carbon steel	304 SS, 316 SS
6	Flange, Cooling water inlet	A105	A182-F304, A182-F316, A182-F316L
7	Flange, Cooling water outlet	A105	A182-F304, A182-F316, A182-F316L
8	Cover	A36	304 SS, 316 SS

► Other Special materials and specifications are available upon customer's request.

SLOT DIPPING DEVICE

NOMINAL SIZE

- Size 4", 6", and 8"

CONNECTIONS

- ANSI/ASME B16.5 Class 150 Flange
- KS/JIS 10K Flange

The Sewon SGDD Slot Dipping & Sampling Device is designed to take a sample from the storage tank containing volatile liquid, and to protect operator minimizing exposure from vapor or gas.

It is operated mechanically, and no need any external power supply.

The device ensures leak tight, if correctly installed and used, when normal operating condition, except sampling. Every precaution must be taken to obtain samples, and particular care should be taken in handling dangerous materials to prevent serious injury.

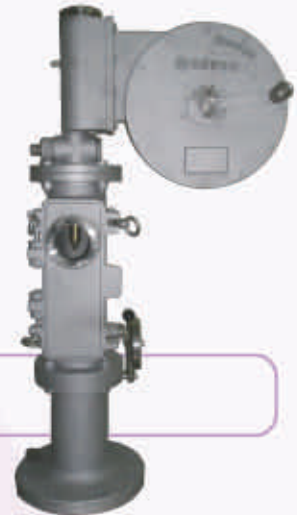





SPECIFICATIONS

- Body materials : Aluminum casting or Stainless steel
- Connection : ANSI Class 150 or KS/JIS 10K
- Inlet size : 4", 6", or 8"
- Scale length : 30m, 50m, or 100m
- Capacities of sampling bottle : 300cc / 600cc
- O-ring material : Viton, NBR, or other materials are available on customer's request. Consult our factory for special application or special design.

BASIC ORDERING INFORMATION

- Fluid Handling
- Size and Connection
- Operating Temperature & Pressure Flanges
- Material

HOW TO ORDER

MODEL	INLET SIZE	BODY MATERIALS	FLANGE DRILLING	OPTION
 ↓ SGDD	 ↓ 04 : 04 " 06 : 06 " 08 : 08 " SS : Special	 ↓ C : Carbon Steel 4 : 304 S.S 5 : 304L S.S 6 : 316 S.S 7 : 316L S.S A : Aluminum S : Special Material	 ↓ AR : ANSI Class 150 RF AF : ANSI Class 150 RF KR : KS/JIS 10K RF KF : KS/JIS 10K FF NO : NO Drilling SS : Special	 ↓ Others Seat Material T : PTFE Teflon® N : NBR(Buna-N)O-ring V : Viton O-Ring M : Metal to Metal

EXAMPLE

SGDD-06-A-AF-TO

Means a 6" model SGDD with Aluminum body, ANSI/ASME Class 150 RF flange drilling and no other option.

■ Scopes

The API Standard 2000 covers aboveground liquid petroleum or petroleum products storage tank and aboveground and underground refrigerated storage tanks designed for operation at pressures from vacuum through 15 psi.

■ Definition of terms

Accumulation:

The Pressure increase in a tank over its maximum allowable working pressure when the vent valve is relieving.

Barrel:

A liquid unit of mean equal to 42US gallons(0.159 cubic meters)

BTU:

British Thermal Unit, a unit of heat that will increase the temperature of one pound of water one degree Fahrenheit.

Emergency venting:

The Venting required when an abnormal condition, such as ruptured internal heating coils or an external fire, exists either inside or outside of a tank

Nonrefrigerated tank:

A container that stores material in a liquid state without the aid of refrigeration either by evaporation of the tank contents or by a circulating refrigeration system. Generally, the storage temperature will be close to or higher than ambient temperature.

Normal Venting:

The venting required because of operational requirements of atmosphere changes.

Overpressure:

The pressure increase at the valve inlet above the set pressure, when the valve is relieving, expressed in pressure units or as a percentage of the set pressure. It is the same as accumulation when the valve is set at the maximum allowable working pressure and the inlet piping losses are zero.

Petroleum:

Crude oil

Petroleum Product:

Hydrocarbon materials or other products derived from crude oil.

PV valve:

A weight loaded, pilot operated, or spring loaded valve, used to relieve excess pressure and/or vacuum that has developed in a tank.

Rated Relieving Capacity:

The flow capacity of a relief device expressed in terms of air flow at standard conditions(SCFH or Nm³/h)at a designated pressure or vacuum.

Refrigerated tank:

A container that stores liquid at a temperature below atmospheric temperature with or without the aid of refrigeration of the tank contents or by a circulating refrigeration system.

Relief device:

Any device used to relieve excess pressure and/or vacuum that has developed in a tank.

Relieving pressure:

The pressure at the inlet of a relief device when it is flowing at the required relieving capacity.

Required flow capacity:

The flow capacity of a relief device required to prevent excessive overpressure or vacuum in a tank under the most severe operating or emergency conditions.

SCFH:

Standard cubic feet of air or gas per hour(same as free air or free gas)at a temperature of 60° F (15.6 °C) and a pressure of 14.7 pounds per square inch absolute(1.014 bar absolute)

Nm³/h:

Normal cubic meters of air or gas per hour at a temperature of 0°C and pressure of 1.014bar.

Set Pressure :

The gauge pressure at the device inlet at which the relief device is set to start opening under service condition(measurable lift begins)

Thermal Inbreathing:

The movement of air or blanketing gas into a tank when vapors in the tank contract or condense as a result of weather changes conditions(e.g, a decrease in atmospheric temperature)

Thermal Outbreathing :

The movement of vapors out of a tank when vapors in the tank expand and liquid in the tank vaporizes as a result of weather changes condition(e.g, an increase in atmospheric temperature)

Wetted Area :

The surface area of a tank exposed to liquid on the interior and heat from a fire on the exterior.

Normal and Thermal Venting Capacity Requirements for Non-Refrigerated Aboveground Tank

Inbreathing Requirements (Nm ³ /h of air)		Out-breathing Requirements (Nm ³ /h of air)		
Liquid movement (V _{LI})	Thermal effect (V _{TI})	Flash point	Liquid movement (V _{LO})	Thermal effect (V _{TO})
0.94 × R _e	if C ≤ 3,180m ³ , V _{TI} = 0.169 × C	Flash point ≥ 37.8°C	1.01 × R _f	0.6 × V _{TI}
	if C > 3,180m ³ , V _{TI} = 0.577(A _s + A _r)	Flash point < 37.8°C	2.02 × R _f	V _{TI}

where,

- A_s = Area of shell(m²)
- A_r = Area of roof(m²)
- C = Tank capacity(m³)
- V_{LI} = Inbreathing requirements for liquid movement out(Nm³/h)
- V_{LO} = Out-breathing requirements for liquid movement in(Nm³/h)
- V_{TI} = Inbreathing requirements for thermal venting capacity(Nm³/h)
- V_{TO} = Out-breathing requirements for thermal venting capacity(Nm³/h)
- R_f = Maximum filling rate(Nm³/h)
- R_e = Maximum emptying rate(Nm³/h)

Emergency Venting Capacity Requirements

When storage tanks are exposed to fire, the venting rate may exceed the rate resulting from a combination of normal thermal effects and liquid movement. In such case, the construction of the tank will determine whether additional venting capacity must be provided.

If a tank is not provided with a weak roof-to-shell attachment, then additional procedures shall be considered to evaluate the required venting capacity for fire exposure.

$$\text{Nm}^3/\text{h} = 881.55 \times \frac{QF}{L} \times \left(\frac{T}{M} \right)^{0.5}$$

where,

- Nm³/h = Emergency venting requirement, in normal cubic meters per hour of air
- A = Wetted surface area of the tank(m²)
- F = Environmental factor(for bare metal tank, F=1.0)
- L = Latent heat of vaporization of the stored liquid at the relieving pressure and temperature(J/kg)
- T = Temperature of the relieving vapor in degrees Kelvin
- M = Molecular weight of the vapor
- Q = Heat input from fire exposure, in watts.

Heat input(Q) can be calculated by following Table:

Wetted surface area (m ²)	Design pressure (barg)	Heat Input (watts)
< 18.6	≤ 1.034	Q=63,150A
≥ 18.6 and < 93	≤ 1.034	Q=224,200A ^{0.566}
≥ 93 and < 260	≤ 1.034	Q=630,400A ^{0.398}
≥ 260	0.07 < D.P ≤ 1.034	Q=43,200A ^{0.82}
≥ 260	≤ 0.07	Q=4,129,700A

Where a lesser degree of accuracy can be tolerated, the emergency venting capacity requirement can be determined from following Table.

Wetted surface area (m ²)	Design pressure (barg)	Nm ³ /h
< 260	≤ 1.034	See below Table
≥ 260	≤ 0.07	19,910
≥ 260	0.07 < D.P ≤ 1.034	208.2FA ^{0.82}

Emergency venting capacity requirement

Wetted area (m ²)	Venting requirement (Nm ³ /h)	Wetted area (m ²)	Venting requirement (Nm ³ /h)	Wetted area (m ²)	Venting requirement (Nm ³ /h)
2	608	17	5,172	80	12,911
3	913	19	5,780	90	13,801
4	1,217	22	6,217	110	15,461
5	1,521	25	6,684	130	15,751
6	1,825	30	7,411	150	16,532
7	2,130	35	8,086	175	17,416
8	2,434	40	8,721	200	18,220
9	2,738	45	9,322	230	19,102
11	3,347	50	9,895	260	19,910
13	3,955	60	10,971	> 260	-
15	4,563	70	11,971		

Wetted Area of a Storage Tank or Vessel

Vertical Tanks

The wetted area is equal to total surface area of the vertical shell to a height of 9.14 meters above grade. For a vertical tank setting on the ground, the area of the ground plates is not to be included as wetted area.

For vertical tank supported above grade, a portion of the area of the bottom is to be included as additional wetted surface. The portion of the bottom area exposed to a fire depends on the diameter and elevation of the tank above grade.

Horizontal Tanks

The wetted area is equal to 75 percent of the total surface area or the surface area to a height of 9.14 meters above grade, whichever is greater.

Sphere Tanks

The wetted area is equal to 55 percent of the total surface area or surface area to height of 9.14 meters above grade, whichever is greater.

Chemicals Compatibility

Chemicals Compatibility List for Metals and Elastomers

No.	Chemical	Metal					Elastomer			
		Aluminum	Cast Iron	304 S.S	316 S.S	Hastelloy	NBR	Neoprene	PTFE (Viton)	Viton
1	Acetaldehyde	B	C	A	A	A	D	C	A	D
2	Acetic Acid	B	D	D	B	A	C	C	A	B
3	Acetic Acid 20%	B	D	B	A	A	B	A	A	B
4	Acetic Acid 80%	B	D	D	B	A	C	C	A	B
5	Acetic Acid, Glacial	B	D	C	A	A	C	D	A	D
6	Acetic Anhydride	A	D	B	A	A	D	A	A	D
7	Acetone	A	A	A	A	A	D	C	A	D
8	Acetyl Chloride(dry)	D	B	A	A	A	D	D	A	A
9	Acetylene	A	A	A	A	N/A	B	B	A	A
10	Alcohols:Ethyl	B	B	A	A	A	C	A	A	A
11	Alcohols:Methyl	A	A	A	A	A	A	A	A	C
12	Aluminum Chloride	D	D	B	B	A	A	A	A	A
13	Aluminum Chloride 20%	D	D	D	C	A	A	A	A	A
14	Amines	B	D	A	A	B	D	B	A	D
15	Ammonia 10%	A	A	A	A	A	A	A	A	D
16	Ammonia Nitrate	C	A	A	A	N/A	C	C	A	D
17	Ammonia, liquid	A	A	B	A	B	C	A	A	D
18	Ammonium Acetate	A	N/A	B	A	N/A	B	A	A	A
19	Benzene	B	A	B	B	B	D	D	A	A
20	Benzene Sulfonic Acid	D	N/A	B	B	B	D	A	A	A
21	Benzoic Acid	B	D	B	B	B	D	B	A	A
22	Benzol	B	A	A	A	B	D	D	A	A
23	Butadiene	A	N/A	A	A	C	D	B	A	B
24	Butane	A	N/A	A	A	A	A	A	A	A
25	Butanol(Butyl Alcohol)	B	N/A	A	A	B	A	A	A	A
26	Butyl Amine	A	N/A	N/A	A	B	N/A	D	A	D
27	Butyl Ether	A	N/A	N/A	A	N/A	B	D	A	D
28	Butylene	A	N/A	A	A	N/A	A	D	A	A
29	Butyric Acid	B	D	B	B	A	D	D	A	B
30	Carbolic Acid(Phenol)	A	D	B	B	A	D	D	A	A
31	Carbon Dioxide(dry)	B	D	A	A	A	A	B	A	B
32	Carbon Dioxide(wet)	A	D	A	A	A	A	B	A	B
33	Carbon Disulfide	A	A	A	B	B	D	D	A	A
34	Carbon Monoxide	A	A	A	A	B	A	B	A	A
35	Carbon Tetrachloride	D	D	B	B	A	D	D	A	A
36	carbon Tetrachloride(dry)	D	N/A	B	B	B	C	D	A	A
37	Carbon Tetrachloride(wet)	D	C	A	A	B	D	D	A	N/A
38	Chloric Acid	D	D	D	C	A	N/A	N/A	A	N/A
39	Chlorine(dry)	C	D	A	B	A	B	C	A	A
40	Chlorine Water	D	N/A	C	C	A	D	D	A	A
41	Chlorine, Anhydrous Liquid	D	D	C	C	D	D	D	A	A
42	Chloroacetic Acid	D	D	B	A	A	D	D	A	D
43	Dichloroethane	B	N/A	B	B	A	D	D	A	C
44	Diesel Fuel	A	A	A	A	B	A	B	A	A
45	Diethyl Ether	B	N/A	B	B	B	D	D	A	D
46	Diethylamine	B	B	A	A	A	C	A	D	A
47	Diethylene Glycol	B	A	A	A	B	A	A	A	A
48	Dimethyl Aniline	A	N/A	B	B	B	D	D	A	D
49	Ether	B	C	A	A	B	D	D	A	C
50	Ethyl Acetate	A	A	B	B	A	D	D	A	D
51	Ethyl Benzoate	N/A	N/A	N/A	N/A	N/A	D	D	A	A
52	Ethyl Chloride	B	C	A	A	B	A	C	A	A
53	Ethyl Ether	B	C	B	B	B	D	D	A	D
54	Ethylene Chloride	B	N/A	B	B	N/A	D	D	A	B
55	Ethylene Chlorohydrin	B	N/A	B	B	B	D	A	A	A
56	Fuel Oils	C	A	A	A	A	A	B	B	A
57	Hexane	A	A	A	A	A	A	B	A	A
58	Hydrobromic Acid 20%	D	D	D	D	A	D	D	N/A	A
59	Hydrochloric Acid 100%	D	D	D	D	A	D	D	A	A
60	Hydrochloric Acid 20%	D	D	D	D	A	N/A	C	A	A
61	Hydrochloric Acid 37%	D	D	D	D	B	B	B	A	A
62	Hydrochloric Acid, Dry Gas	D	N/A	D	D	A	N/A	N/A	A	N/A
63	Hydrogen Gas	A	N/A	A	A	A	A	A	A	A
64	Isooctane	A	N/A	A	A	N/A	A	B	A	A

No.	Chemical	Metal					Elastomer			
		Aluminum	Cast Iron	304 S.S	316 S.S	Hastelloy-	NBR	Neoprene	PTFE (Teflon)	Viton
65	Isopropyl Acetate	D	N/A	C	A	B	D	D	A	D
66	Isopropyl Ether	A	N/A	A	A	A	B	D	A	D
67	Isotane	D	N/A	N/A	N/A	N/A	A	D	N/A	A
68	Kerosene	A	A	A	A	B	A	A	A	A
69	Ketones	B	N/A	A	A	A	D	D	A	D
70	Lithium Chloride	D	A	A	A	N/A	A	A	A	A
71	Lithium Hydroxide	D	N/A	B	B	B	C	N/A	A	N/A
72	Lubricants	A	A	A	A	A	A	D	A	A
73	Methane	A	N/A	A	A	A	A	B	A	A
74	Methanol(Methyl Alcohol)	A	A	A	A	A	A	A	A	C
75	Methyl Acetate	A	A	A	B	A	D	B	A	D
76	Methyl Acetone	A	A	A	A	N/A	D	D	A	D
77	Methyl Acrylate	N/A	A	A	N/A	N/A	D	B	N/A	D
78	Methyl Ethyl Ketone	B	A	A	A	A	D	D	A	D
79	Methyl Ethyl Ketone Peroxide	N/A	N/A	N/A	N/A	N/A	D	D	N/A	D
80	Methyl Isobutyl Ketone	B	C	B	B	A	D	D	A	D
81	Methyl Isopropyl Ketone	A	C	A	A	N/A	D	D	A	D
82	Methyl Methacrylate	N/A	C	B	B	N/A	D	D	N/A	D
83	Methylamine	A	A	A	A	N/A	B	N/A	A	D
84	Methylene Chloride	C	B	B	B	B	D	N/A	A	B
85	Natural Gas	A	A	A	A	N/A	A	A	A	A
86	Nitric Acid(20%)	D	D	A	A	A	D	D	A	A
87	Nitric Acid(50%)	D	D	A	A	A	D	D	A	A
88	Nitric Acid(5~10%)	A	D	A	A	A	D	B	A	A
89	Nitric Acid(Cncentrated)	D	D	A	A	B	D	D	A	A
90	Petroleum	D	N/A	A	A	N/A	A	B	A	A
91	Phenol(10%)	A	D	B	B	B	D	D	A	A
92	Propane(liquefied)	A	A	A	A	A	A	C	A	A
93	Propylene	A	A	A	A	N/A	D	D	A	A
94	Propylene Glycol	B	A	B	B	B	A	C	A	A
95	Sea Water	B	D	C	C	A	A	B	A	A
96	Sulfuric Acid(<10%)	D	C	B	B	B	A	B	A	A
97	Sulfuric Acid(10~75%)	D	D	D	D	B	B	B	A	A
98	Sulfuric Acid(75~100%)	D	D	D	D	B	C	D	A	A
99	Sulfuric Acid(cold concentrated)	B	D	B	B	A	D	D	A	B
100	Sulfuric Acid(hot concentrated)	D	D	C	C	D	D	D	A	A
101	Sulfurous Acid	B	D	B	B	B	B	C	A	A
102	Sulfuryl Chloride	N/A	N/A	N/A	N/A	N/A	N/A	N/A	A	N/A
103	Tannic Acid	C	C	A	A	B	A	A	A	A
104	Trichloroethane	D	B	B	B	A	D	D	A	A
105	Vinyl Acetate	A	B	B	B	N/A	D	D	A	A
106	Vinyl Chloride	B	B	A	A	A	D	D	A	A
107	Xylene	A	B	B	B	A	D	D	A	B

Ratoms - Chemical Effect

- A = Excellent
 B = Good -- Minor Effect, slight corrosion or discoloration
 C = Fair -- Moderate Effect, not recommended for continuous use.
 Softening, loss of strength, swelling may occur
 D = Severe Effect and NOT recommended for any use
 N/A = Information Not Available

Variations in chemical behavior during handling due to factors such as temperature, pressure, and concentration can cause equipment to fail, even though it passed an initial test.

Disclaimer

Although the information and recommendations at this document are presented in good faith and believed to be correct, Sewon Q&Tech Co., Ltd. makes no representations or warranties as to the completeness or accuracy of the information. In no event will Sewon Q&Tech Co.,Ltd. be responsible for damages of any nature whatsoever resulting from the use of or reliance upon information from this document or the products to which the information refers.

Sewon Q&Tech Co.,Ltd. does not warrant the accuracy of this document and has no liability for any errors or omissions. Sewon Q&Tech Co.,Ltd. does not warrant (neither express or implied) that the information in this list is accurate or complete or that any material is suitable for any purpose.